

SCXI-1180/1181

User Manual

Feedthrough Panel and Breadboard Module

March 1995 Edition

Part Number 371062A-01

**© Copyright 1991, 1995 National Instruments Corporation.
All Rights Reserved.**

National Instruments Corporate Headquarters

6504 Bridge Point Parkway

Austin, TX 78730-5039

(512) 794-0100

Technical support fax: (800) 328-2203

(512) 794-5678

Branch Offices:

Australia (03) 879 9422, Austria (0662) 435986, Belgium 02/757.00.20, Canada (Ontario) (519) 622-9310,

Canada (Québec) (514) 694-8521, Denmark 45 76 26 00, Finland (90) 527 2321, France (1) 48 14 24 24,

Germany 089/741 31 30, Italy 02/48301892, Japan (03) 3788-1921, Mexico 95 800 010 0793,

Netherlands 03480-33466, Norway 32-84 84 00, Singapore 2265886, Spain (91) 640 0085, Sweden 08-730 49 70,

Switzerland 056/20 51 51, Taiwan 02 377 1200, U.K. 0635 523545

Limited Warranty

The SCXI-1180 and SCXI-1181 are warranted against defects in materials and workmanship for a period of one year from the date of shipment, as evidenced by receipts or other documentation. National Instruments will, at its option, repair or replace equipment that proves to be defective during the warranty period. This warranty includes parts and labor.

A Return Material Authorization (RMA) number must be obtained from the factory and clearly marked on the outside of the package before any equipment will be accepted for warranty work. National Instruments will pay the shipping costs of returning to the owner parts which are covered by warranty.

National Instruments believes that the information in this manual is accurate. The document has been carefully reviewed for technical accuracy. In the event that technical or typographical errors exist, National Instruments reserves the right to make changes to subsequent editions of this document without prior notice to holders of this edition. The reader should consult National Instruments if errors are suspected. In no event shall National Instruments be liable for any damages arising out of or related to this document or the information contained in it.

EXCEPT AS SPECIFIED HEREIN, NATIONAL INSTRUMENTS MAKES NO WARRANTIES, EXPRESS OR IMPLIED, AND SPECIFICALLY DISCLAIMS ANY WARRANTY OF MERCHANTABILITY OR FITNESS FOR A PARTICULAR PURPOSE. CUSTOMER'S RIGHT TO RECOVER DAMAGES CAUSED BY FAULT OR NEGLIGENCE ON THE PART OF NATIONAL INSTRUMENTS SHALL BE LIMITED TO THE AMOUNT THERETOFORE PAID BY THE CUSTOMER. NATIONAL INSTRUMENTS WILL NOT BE LIABLE FOR DAMAGES RESULTING FROM LOSS OF DATA, PROFITS, USE OF PRODUCTS, OR INCIDENTAL OR CONSEQUENTIAL DAMAGES, EVEN IF ADVISED OF THE POSSIBILITY THEREOF. This limitation of the liability of National Instruments will apply regardless of the form of action, whether in contract or tort, including negligence. Any action against National Instrument must be brought within one year after the cause of action accrues. National Instruments shall not be liable for any delay in performance due to causes beyond its reasonable control. The warranty provided herein does not cover damages, defects, malfunctions, or service failures caused by owner's failure to follow the National Instruments installation, operation, or maintenance instructions; owner's modification of the product; owner's abuse, misuse, or negligent acts; and power failure or surges, fire, flood, accident, actions of third parties, or other events outside reasonable control.

Copyright

Under the copyright laws, this publication may not be reproduced or transmitted in any form, electronic or mechanical, including photocopying, recording, storing in an information retrieval system, or translating, in whole or in part, without the prior written consent of National Instruments Corporation.

Trademarks

LabVIEW[®], LabWindows[®], NI-DAQ[®], and RTSI[®] are trademarks of National Instruments Corporation.

Product and company names listed are trademarks or trade names of their respective companies.

WARNING REGARDING MEDICAL AND CLINICAL USE OF NATIONAL INSTRUMENTS PRODUCTS

National Instruments products are not designed with components and testing intended to ensure a level of reliability suitable for use in treatment and diagnosis of humans. Applications of National Instruments products involving medical or clinical treatment can create a potential for accidental injury caused by product failure, or by errors on the part of the user or application designer. Any use or application of National Instruments products for or involving medical or clinical treatment must be performed by properly trained and qualified medical personnel, and all traditional medical safeguards, equipment, and procedures that are appropriate in the particular situation to prevent serious injury or death should always continue to be used when National Instruments products are being used. National Instruments products are NOT intended to be a substitute for any form of established process, procedure, or equipment used to monitor or safeguard human health and safety in medical or clinical treatment.

Contents

About This Manual	vii
Organization of This Manual	vii
Conventions Used In This Manual.....	vii
Related Documentation.....	viii
Customer Communication	viii

Chapter 1

Introduction	1-1
What Your Kit Should Contain.....	1-1
Optional Software	1-1
Optional Equipment	1-3
Unpacking.....	1-3

Chapter 2

SCXI-1180 Feedthrough Panel	2-1
Description	2-1
SCXI-1180 Installation	2-6
SCXI-1302 Terminal Block.....	2-7
SCXI-1302 Installation	2-7

Chapter 3

SCXI-1181 Breadboard Module	3-1
Description.....	3-1
Breadboarding Area	3-3
Connectors	3-3
SCXIbus Connector Signal Descriptions.....	3-5
Power Supply	3-6
Using and Building Circuits on the SCXI-1181	3-8
Building the Power Supply	3-8
Specifications.....	3-9
Soldering and Desoldering on the SCXI-1181 Module.....	3-10
SCXI-1181 Installation	3-10
SCXI-1181 Signal Connections.....	3-10
SCXI-1300 Terminal Block.....	3-10
SCXI-1300 Onboard Temperature Sensor.....	3-11
Configuration	3-11
Jumper Configuration	3-11
SCXI-1301 Terminal Block.....	3-13
SCXI-1300 and SCXI-1301 Signal Connection	3-14
SCXI-1310 Connector-and-Shell Assembly.....	3-17
SCXI-1330 Connector-and-Shell Assembly.....	3-17
SCXI-1310 and SCXI-1330 Installation.....	3-17

Appendix A

Cabling	A-1
SCXI-1340 Cable Assembly.....	A-1
SCXI-1340 Installation	A-2

SCXI-1351 One-Slot Cable Extender	A-3
SCXI-1351 Installation	A-3
SCXI-1343 Rear Screw Terminal Adapter	A-4
SCXI-1343 Installation	A-4

Appendix B	
Customer Communication	B-1

Glossary	Glossary-1
-----------------------	------------

Index	Index-1
--------------------	---------

Figures

Figure 2-1.	SCXI-1180 Feedthrough Panel	2-1
Figure 2-2.	SCXI-1180 Used as an Extender for an SCXI Module Rear Signal Connector	2-3
Figure 2-3.	SCXI-1180 Used as a Plug-In Board Cable Extender	2-4
Figure 2-4.	SCXI-1180 Used as a Daisy-Chain Cable Extender	2-5
Figure 2-5.	SCXI-1180 Front Panel Installation.....	2-7
Figure 2-6.	SCXI-1302 Parts Locator Diagram.....	2-8
Figure 2-7.	Cover Removal	2-9
Figure 3-1.	SCXI-1181 General-Purpose Breadboard Module	3-1
Figure 3-2.	SCXI-1181 Module Parts Locator Diagram	3-2
Figure 3-3.	SCXI-1181 SCXIbus Connector Pin Assignment	3-4
Figure 3-4.	Schematic of the SCXI-1181 Positive Power Supply.....	3-7
Figure 3-5.	Schematic of the SCXI-1181 Negative Power Supply	3-7
Figure 3-6.	Detail of the SCXI-1181 Power Supply Circuit Layout	3-8
Figure 3-7.	SCXI-1300 Screw Terminal/Connector Pin Assignment	3-12
Figure 3-8.	SCXI-1301 Screw Terminal/Connector Pin Assignment	3-13
Figure 3-9.	SCXI-1300 Parts Locator Diagram.....	3-15
Figure 3-10.	SCXI-1301 Parts Locator Diagram.....	3-16
Figure 3-11.	Building and Mounting the SCXI-1310 or SCXI-1330 Connector-and-Shell Assembly	3-18
Figure A-1.	SCXI-1340 Installation	A-2
Figure A-2.	SCXI-1351 Installation	A-3

Tables

Table 3-1.	SCXI-1181 Recommended Parts List.....	3-9
Table A-1.	SCXI-1343 Pin Connections.....	A-4

About This Manual

This manual describes the mechanical and electrical aspects of the SCXI-1180 and SCXI-1181 and contains information about installing and making connections to the modules. The SCXI-1180 feedthrough panel is a 50-pin cable-extension device for use with National Instruments SCXI products. You use the SCXI-1181 general-purpose breadboard module to build custom signal conditioning circuitry for analog I/O, digital I/O, timing, and control applications.

Organization of This Manual

The *SCXI-1180/1181 User Manual* is organized as follows:

- Chapter 1, *Introduction*, describes the SCXI-1180 feedthrough panel and the SCXI-1181 breadboard module; lists the contents of your SCXI-1180 or SCXI-1181 kit; describes the optional signal conditioning accessories; and explains how to unpack your SCXI-1180 or SCXI-1181.
- Chapter 2, *SCXI-1180 Feedthrough Panel*, describes the SCXI-1180 feedthrough panel in detail, including its function, connection, and installation.
- Chapter 3, *SCXI-1181 Breadboard Module*, describes the SCXI-1181 breadboard module in detail, including its function, connection, and installation. This chapter also includes instructions for soldering and desoldering.
- Appendix A, *Cabling*, explains the installation and operation of the cabling accessories you can use with the SCXI-1180 and SCXI-1181.
- Appendix B, *Customer Communication*, contains forms you can use to request help from National Instruments or to comment on our products and manuals.
- The *Glossary* contains an alphabetical list and description of terms in this manual, including abbreviations, acronyms, metric prefixes, mnemonics, and symbols.
- The *Index* contains an alphabetical list of key terms and topics used in this manual, including the page where you can find each one.

Conventions Used in This Manual

The following conventions are used in this manual.

<i>italics</i>	Italic text denotes emphasis, a cross reference, or an introduction to a key concept.
DIO board	DIO board refers to the National Instruments AT-DIO-32F, MC-DIO-24, MC-DIO-32F, NB-DIO-24, NBDIO-96, NB-DIO-32F, PC-DIO-24, and PC-DIO-96 digital I/O data acquisition boards unless otherwise noted.

MIO board	MIO board refers to the AT-MIO-16, AT-MIO-16D, AT-MIO-16F5, AT-MIO-16X, AT-MIO-64F5, MC-MIO-16, NB-MIO-16, and NB-MIO-16X multichannel I/O data acquisition boards unless otherwise noted.
plug-in board	Plug-in board refers to a variety of plug-in circuit boards such as data acquisition boards, analog output boards, and digital I/O boards.

Abbreviations, acronyms, metric prefixes, mnemonics, symbols, and terms are listed in the *Glossary*.

Related Documentation

The following document contains information that you may find helpful as you read this manual:

- *SCXI-1000/1001 User Manual* (part number 320423-01)

Customer Communication

National Instruments wants to receive your comments on our products and manuals. We are interested in the applications you develop with our products, and we want to help if you have problems with them. To make it easy for you to contact us, this manual contains comment and configuration forms for you to complete. These forms are in Appendix B, *Customer Communication*, at the end of this manual.

Chapter 1

Introduction

This chapter describes the SCXI-1180 feedthrough panel and the SCXI-1181 breadboard module; lists the contents of your SCXI-1180 or SCXI-1181 kit; describes the optional signal conditioning accessories; and explains how to unpack your SCXI-1180 or SCXI-1181.

The SCXI-1180 feedthrough panel consists of a front panel and a 50-pin ribbon-cable assembly used to incorporate unconditioned signals into a compact, rugged SCXI chassis-based system. You can use the SCXI-1302 terminal block for signal breakout.

The SCXI-1181 breadboard module is a general-purpose breadboard module with a power-supply circuit layout and a breadboarding area that you can use for building custom analog, digital, and timing circuits. You can use the SCXI-1181 with the National Instruments SCXI mainframe chassis and accessories.

What Your Kit Should Contain

The contents of the SCXI-1180 kit (part number 776572-80) and the SCXI-1181 kit (part number 776572-81) are listed as follows.

Kit Name	Kit Part Number	Kit Components	Part Number
SCXI-1180 kit	776572-80	SCXI-1180 feedthrough panel <i>SCXI-1180/1181 User Manual</i>	181710-01 320424-01
SCXI-1181 kit	776572-81	SCXI-1181 breadboard module <i>SCXI-1180/1181 User Manual</i> 50-pin rear signal connector 96-pin front signal connector	181715-01 320424-01 760373-01 760208-96

If your kit is missing any of the components, contact National Instruments.

Optional Software

When you use the PC, AT, and MC data acquisition boards in combination with an SCXI module and the SCXI-1180 or SCXI-1181, you can use LabVIEW for Windows or LabWindows for DOS. LabVIEW and LabWindows are innovative program development software packages for data acquisition and control applications. LabVIEW uses graphical programming, while LabWindows enhances Microsoft C and QuickBASIC. Both packages include extensive libraries for data acquisition, instrument control, data analysis, and graphical data presentation.

Your National Instruments data acquisition board is shipped with the NI-DAQ software. NI-DAQ has a library of functions that you can call from your application programming environment. These functions include routines for analog input (A/D conversion), buffered data acquisition (high-speed A/D conversion), analog output (D/A conversion), waveform generation, digital I/O, counter/timer, SCXI, RTSI, and self-calibration. NI-DAQ maintains a consistent software interface among its different versions so you can switch between platforms with minimal modifications to your code.

You can use the SCXI-1180 or SCXI-1181, together with the PC, AT, and MC data acquisition boards and an SCXI module, with NI-DAQ software for DOS/Windows/LabWindows. NI-DAQ software for DOS/Windows/LabWindows comes with language interfaces for Professional BASIC, Turbo Pascal, Turbo C, Turbo C++, Borland C++, and Microsoft C for DOS; and Visual Basic, Turbo Pascal, Microsoft C with SDK, and Borland C++ for Windows. NI-DAQ software for DOS/Windows/LabWindows is on high-density 5.25 in. and 3.5 in. diskettes.

You can use the SCXI-1180 or SCXI-1181, together with the NB Series data acquisition boards and an SCXI module, with LabVIEW, a software system that features interactive graphics, a state-of-the-art user interface, and a powerful graphical programming language. The LabVIEW Data Acquisition VI Library, a series of virtual instruments (VIs) for using LabVIEW with National Instruments boards, is included with LabVIEW. The LabVIEW Data Acquisition VI Library is functionally equivalent to the NI-DAQ software for Macintosh.

You can also use the SCXI-1180 or SCXI-1181, combined with the NB Series data acquisition boards and an SCXI module, with NI-DAQ software for Macintosh. NI-DAQ software for Macintosh, which is shipped with all National Instruments Macintosh data acquisition boards, comes with language interfaces for MPW C, THINK C, Pascal, and Microsoft QuickBASIC. Any language that uses Device Manager Toolbox calls can access NI-DAQ software for Macintosh.

Part numbers for these software products are as follows:

Software	Part Number
LabVIEW for Windows LabWindows	776670-01
Standard package	776473-01
Advanced Analysis Library	776474-01
Standard package with the Advanced Analysis Library	776475-01
NI-DAQ software for DOS/Windows/LabWindows	776250-01
LabVIEW for Macintosh	776141-01
NI-DAQ software for Macintosh	776181-01

Optional Equipment

Equipment	Part Number
SCXI-1300 terminal block	776573-00
SCXI-1302 feedthrough terminal block	776573-02
SCXI-1310 96-pin connector-and-shell assembly	776573-10
SCXI-1330 32-pin connector-and-shell assembly	776573-30
SCXI-1340 cable assembly	776574-40
SCXI-1341 Lab-NB/Lab-PC/Lab-PC+ cable assembly	776574-41
SCXI-1342 PC-LPM-16 cable assembly	776574-42
SCXI-1343 rear screw terminal adapter	776574-43
SCXI-1344 Lab-LC cable assembly	776574-44
SCXI-1351 one-slot cable extender	776575-51

Unpacking

Remove the product from its package and inspect the product for loose components or any other sign of damage. Notify National Instruments if the product appears damaged in any way. *Do not* connect a damaged product to your SCXI chassis.

Chapter 2

SCXI-1180 Feedthrough Panel

This chapter describes the SCXI-1180 feedthrough panel in detail, including its function, connection, and installation.

Figure 2-1 shows the SCXI-1180 feedthrough panel.

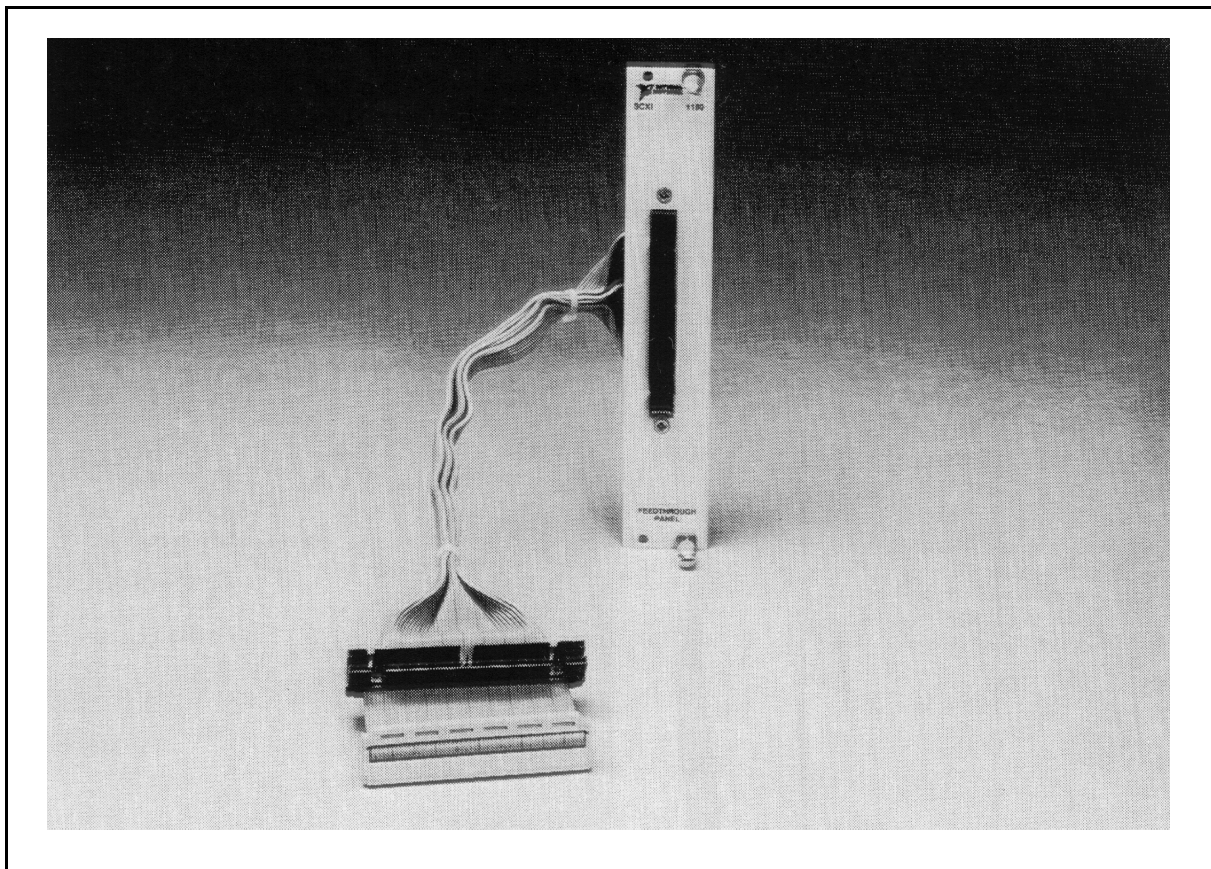

Figure 2-1. SCXI-1180 Feedthrough Panel

Description

The SCXI-1180 feedthrough panel is a 50-pin cable-extension device for use with the National Instruments SCXI product line. You use the SCXI-1180 primarily to extend signal lines for signals that do not require conditioning from the rear to the front of an SCXI chassis. The

SCXI-1180 consists of a front panel and a 50-pin cable assembly that you can use in one of three ways:

- As an extender for the rear signal connector of an SCXI module—you can use the SCXI-1180 to extend the 50-pin rear signal connector of a module to the front of the SCXI chassis, as shown in Figure 2-2.
- As a plug-in board cable extender—with the SCXI-1180 and an SCXI-1340 cable assembly, you can incorporate the signals from a plug-in board, such as a DIO board, into the SCXI chassis system as shown in Figure 2-3. See Appendix A, *Cabling*, for information concerning the SCXI-1340.
- As a daisy-chain extender—with the SCXI-1180 and an SCXI-1340, SCXI-1341, or SCXI-1342 cable assembly, you can access signals on the cable between a module and a plug-in board, particularly those signals that the module does not use, as shown in Figure 2-4. For example, you can access the analog output or digital I/O lines of an MIO board while the analog input lines of the board are connected to a module.

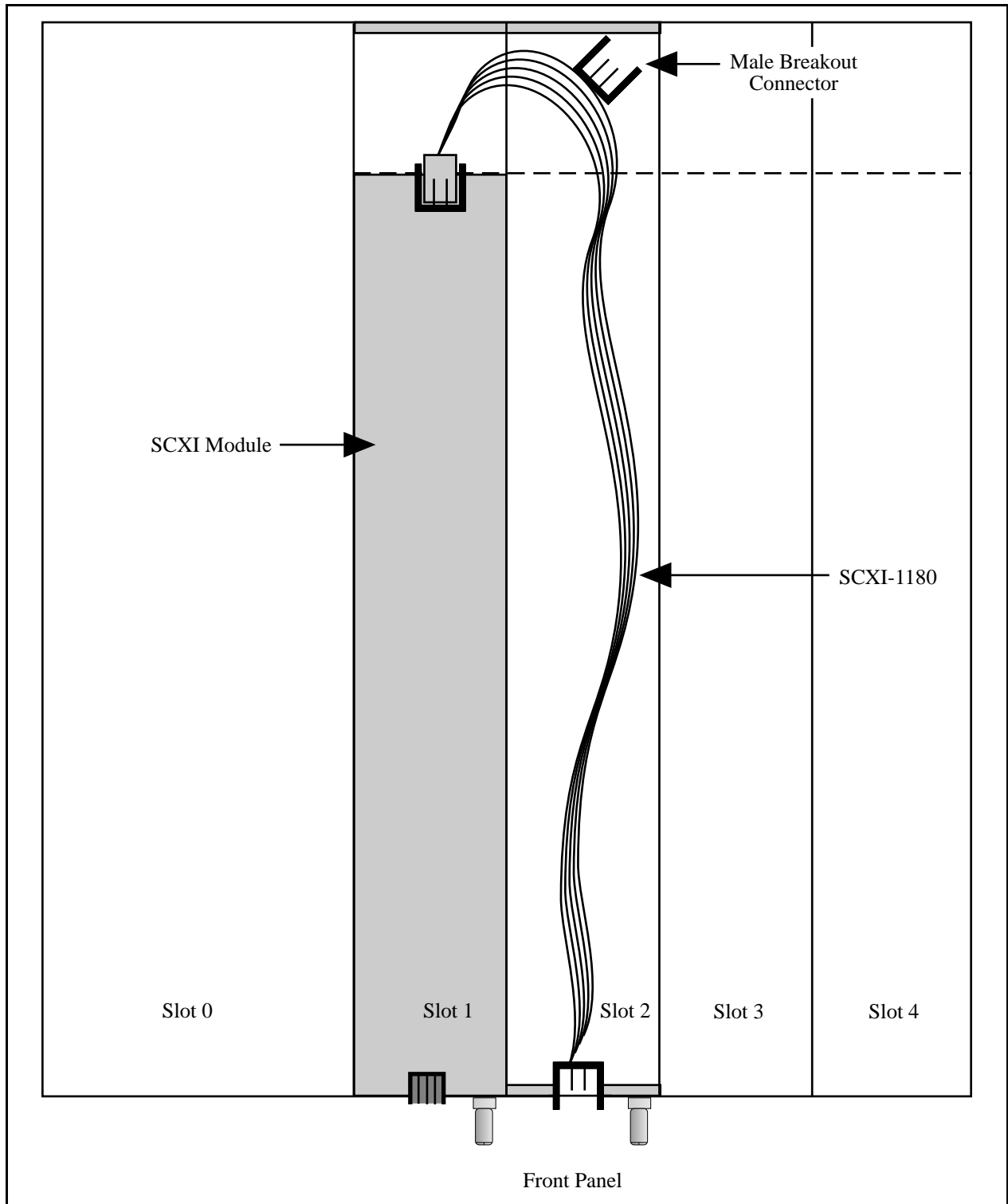

Figure 2-2. SCXI-1180 Used as an Extender for an SCXI Module Rear Signal Connector

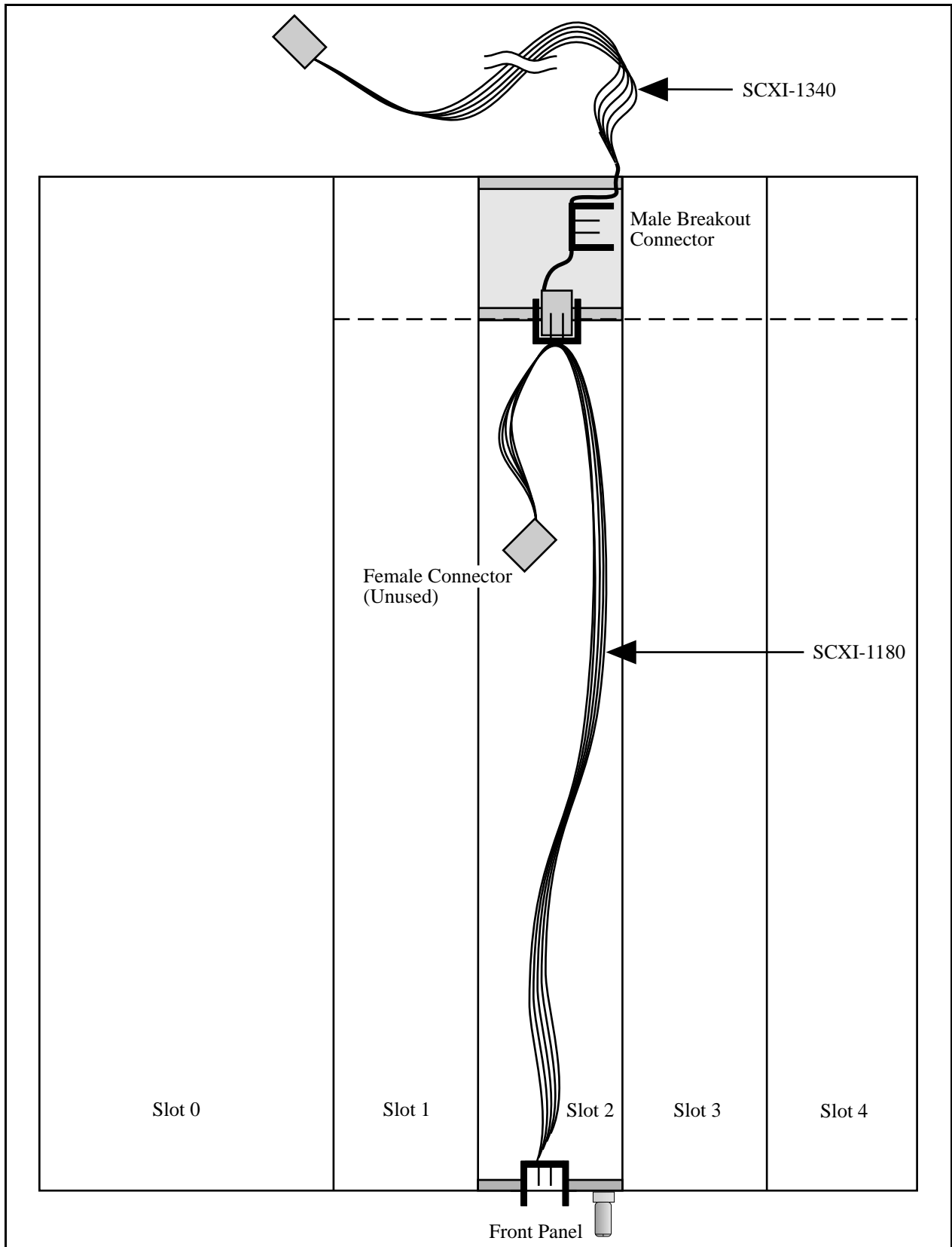

Figure 2-3. SCXI-1180 Used as a Plug-In Board Cable Extender

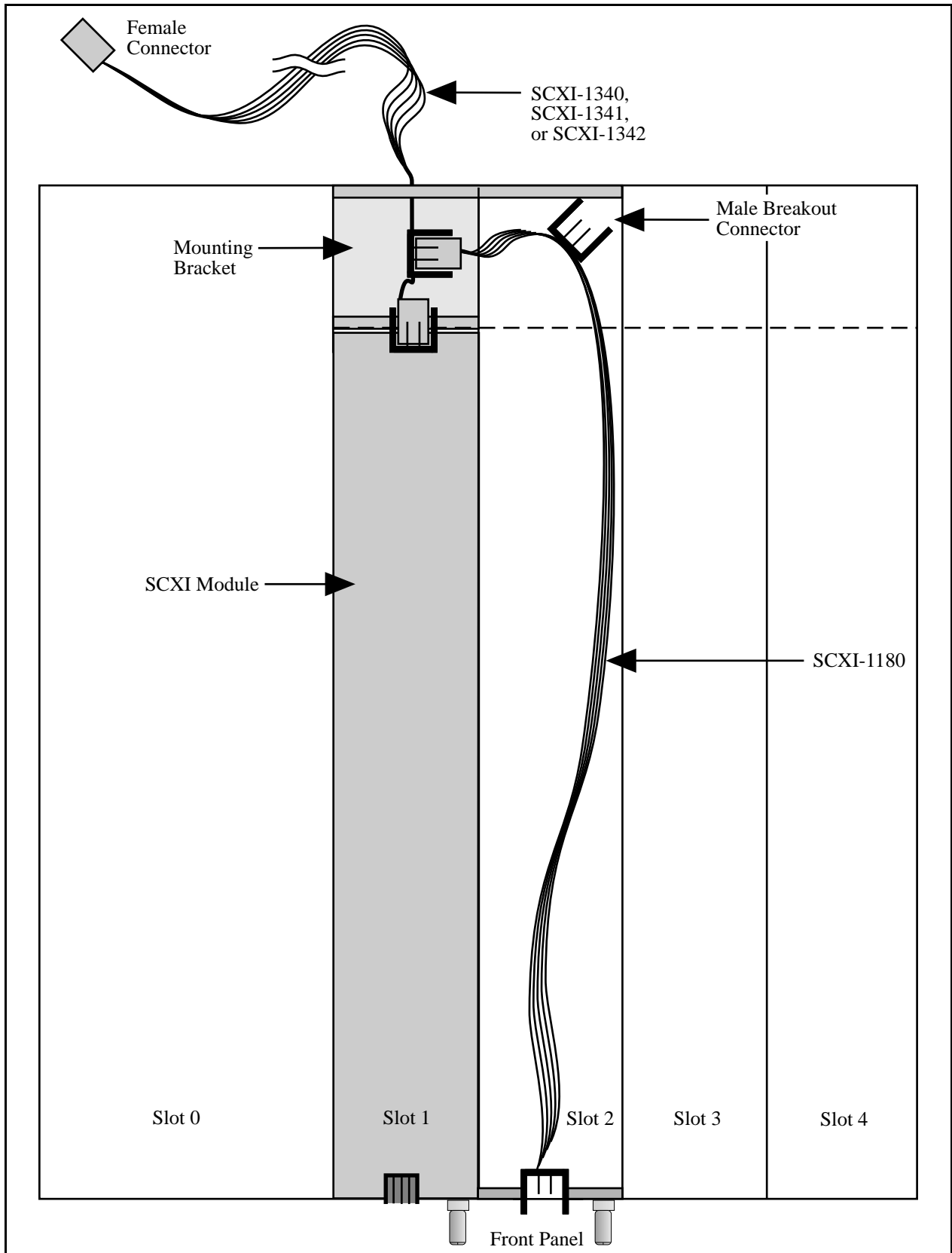

Figure 2-4. SCXI-1180 Used as a Daisy-Chain Cable Extender

SCXI-1180 Installation

Perform the following steps to install the SCXI-1180 into any available SCXI chassis:

1. Turn off the computer that contains the plug-in board or disconnect the board from your SCXI chassis.
2. Turn off the SCXI chassis.
3. Place the SCXI-1180 in an empty slot.
4. Connect the cable as needed for your configuration, as shown in Figures 2-2, 2-3, and 2-4.
5. Screw the front panel of the SCXI-1180 to the top and bottom threaded strips of your SCXI chassis as shown in Figure 2-5.
6. Screw the rear filler panel to the threaded strips in the rear of the chassis.
7. Check the installation.
8. Turn on the SCXI chassis.
9. Turn on the computer or reconnect the board to your chassis.

The SCXI-1180 is installed and ready for operation.

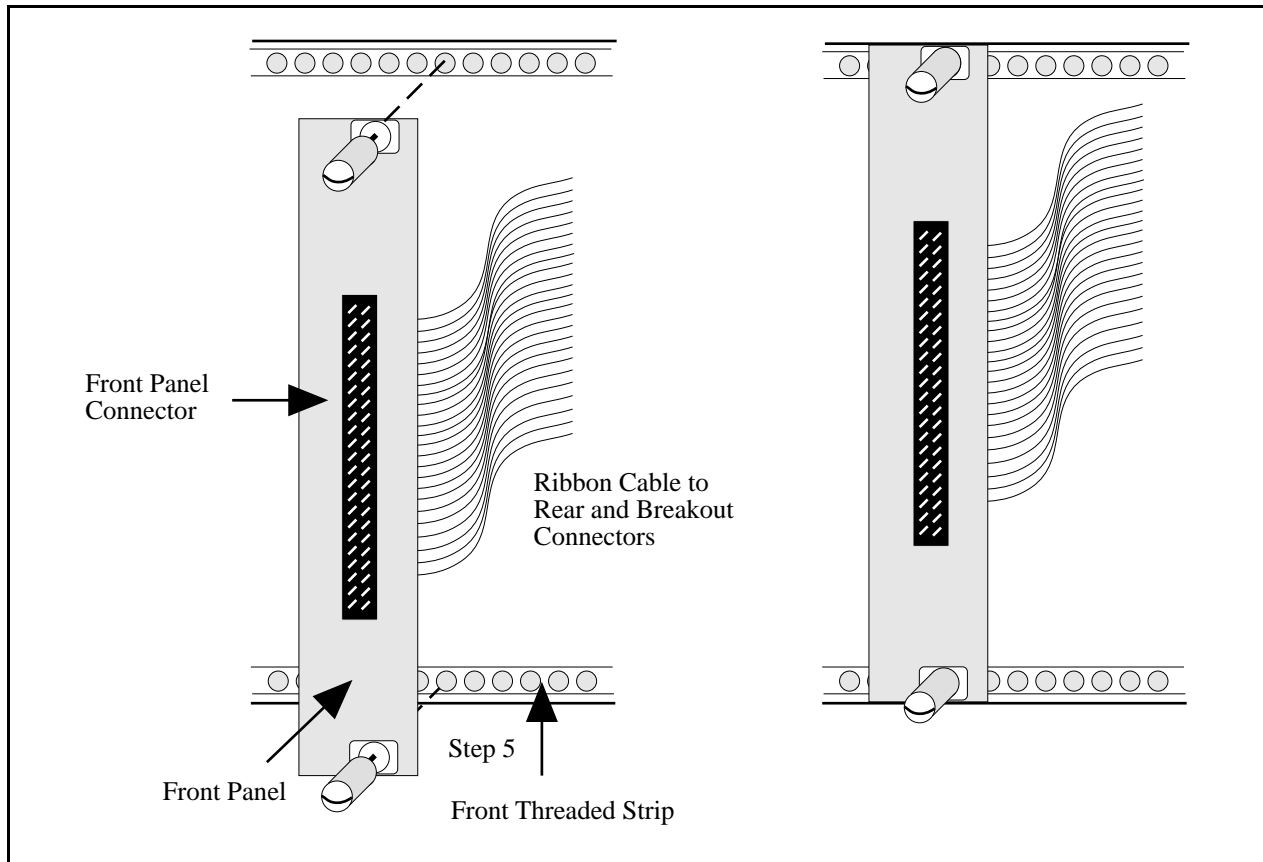

Figure 2-5. SCXI-1180 Front Panel Installation

SCXI-1302 Terminal Block

The National Instruments SCXI-1302 terminal block connects to signals on the SCXI-1180. The terminal block consists of a shielded board with supports to attach the terminal block to the SCXI-1180 front connector. The SCXI-1302 has 50 screw terminals for easy signal-line connection.

SCXI-1302 Installation

Figure 2-6 shows a parts locator diagram for the SCXI-1302 terminal block.

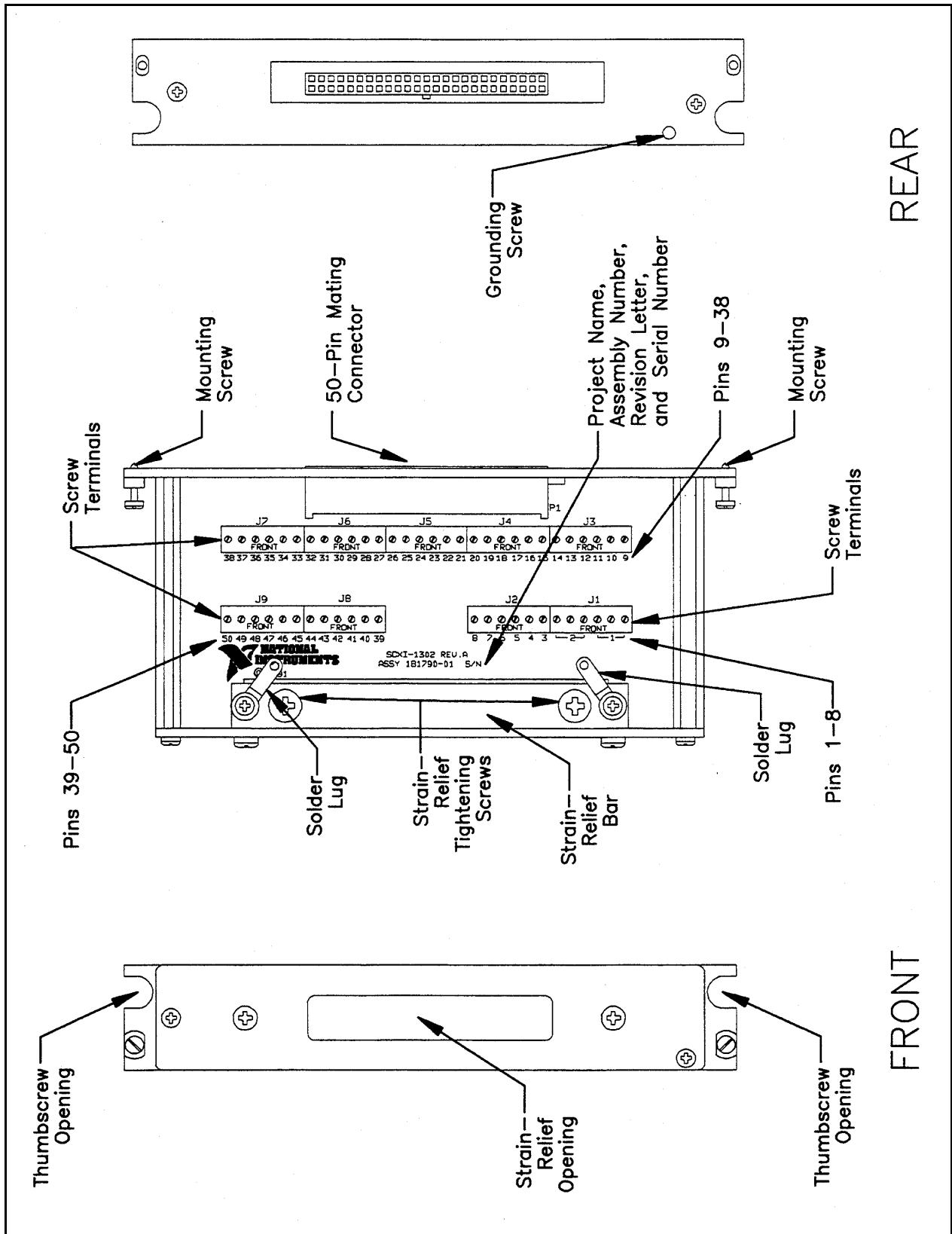

Figure 2-6. SCXI-1302 Parts Locator Diagram

Perform the following steps to connect signals to the SCXI-1302:

1. Remove the grounding screw from the top cover, as shown in Figure 2-7.
2. Pry open the top cover of the shield by twisting a flathead screwdriver in the groove at the bottom of the SCXI-1302.

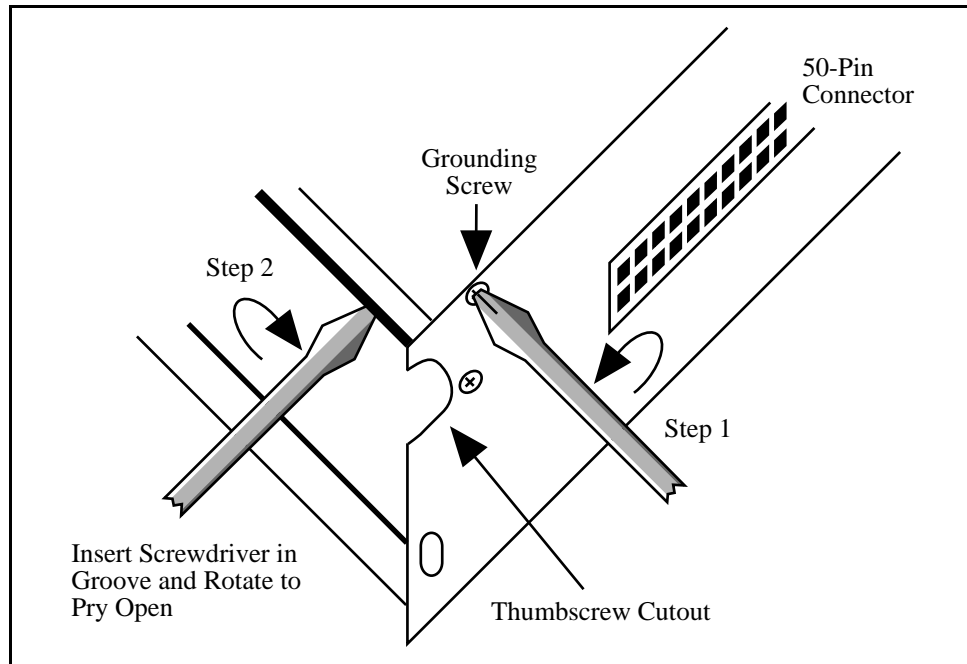

Figure 2-7. Cover Removal

3. Slide the signal wires through the front panel strain-relief opening. You can add padding inside the strain-relief opening if necessary.
4. Connect the wires to the screw terminals.
5. Tighten the large strain-relief screws on each side of the strain-relief bar.
6. Snap the top cover back in place.
7. Reinsert the grounding screw to ensure proper shielding.
8. Connect the SCXI-1302 to the SCXI-1180 front connector and tighten the top and bottom mounting screws.

Chapter 3

SCXI-1181 Breadboard Module

This chapter describes the SCXI-1181 breadboard module in detail, including its function, connection, and installation. This chapter also includes instructions for soldering and desoldering.

Description

You use the SCXI-1181 breadboard module with the National Instruments SCXI product line for custom signal conditioning circuitry in analog I/O, digital I/O, timing, and control applications, and to access the SCXIbus signal lines. The module is fully shielded and comes with a connector kit consisting of a 96-pin front connector and a 50-pin rear signal connector. The SCXI-1181 module has three sections—a breadboarding area, connectors, and a power-supply section. Figure 3-1 shows the SCXI-1181 breadboard module. Figure 3-2 shows the SCXI-1181 parts locator diagram.

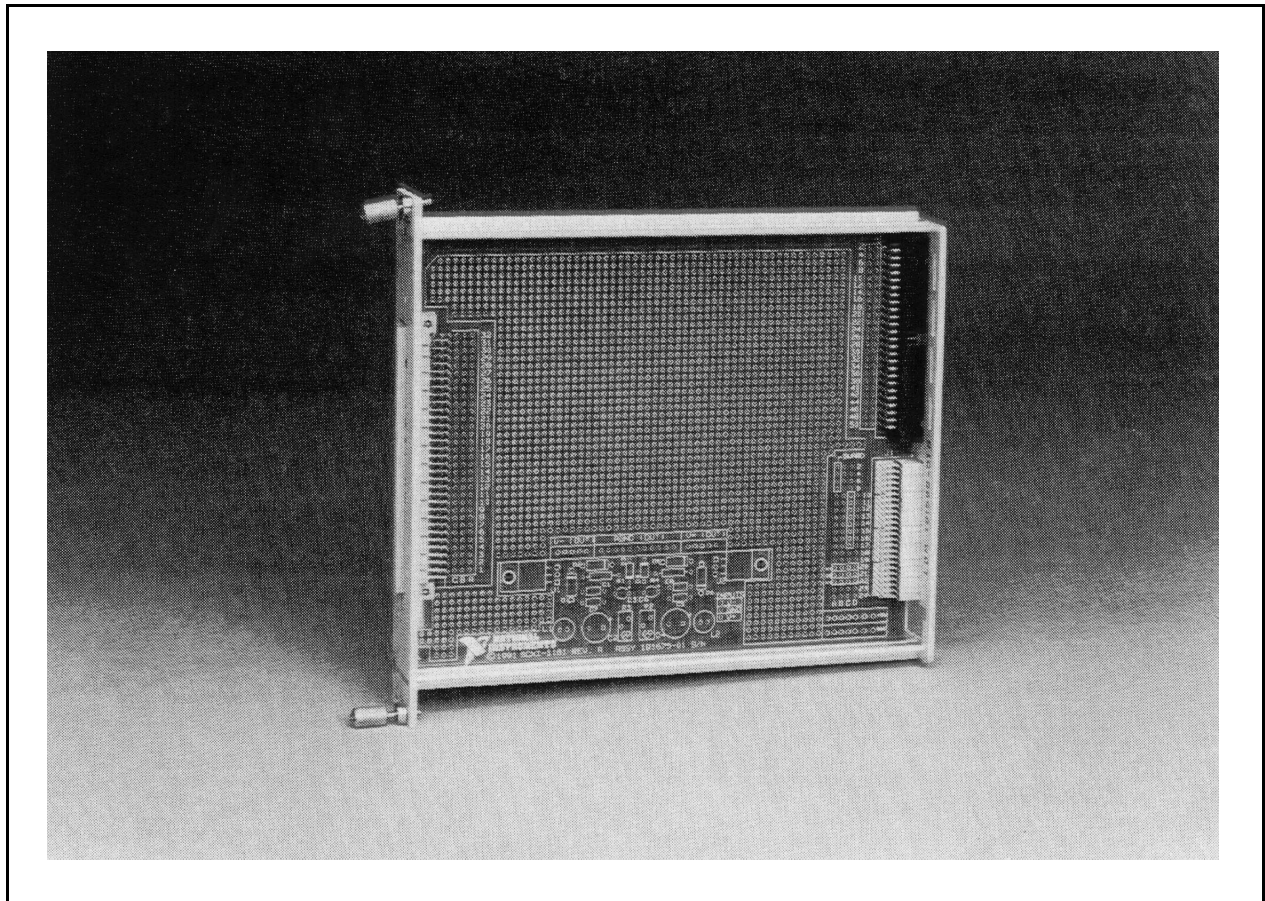

Figure 3-1. SCXI-1181 General-Purpose Breadboard Module

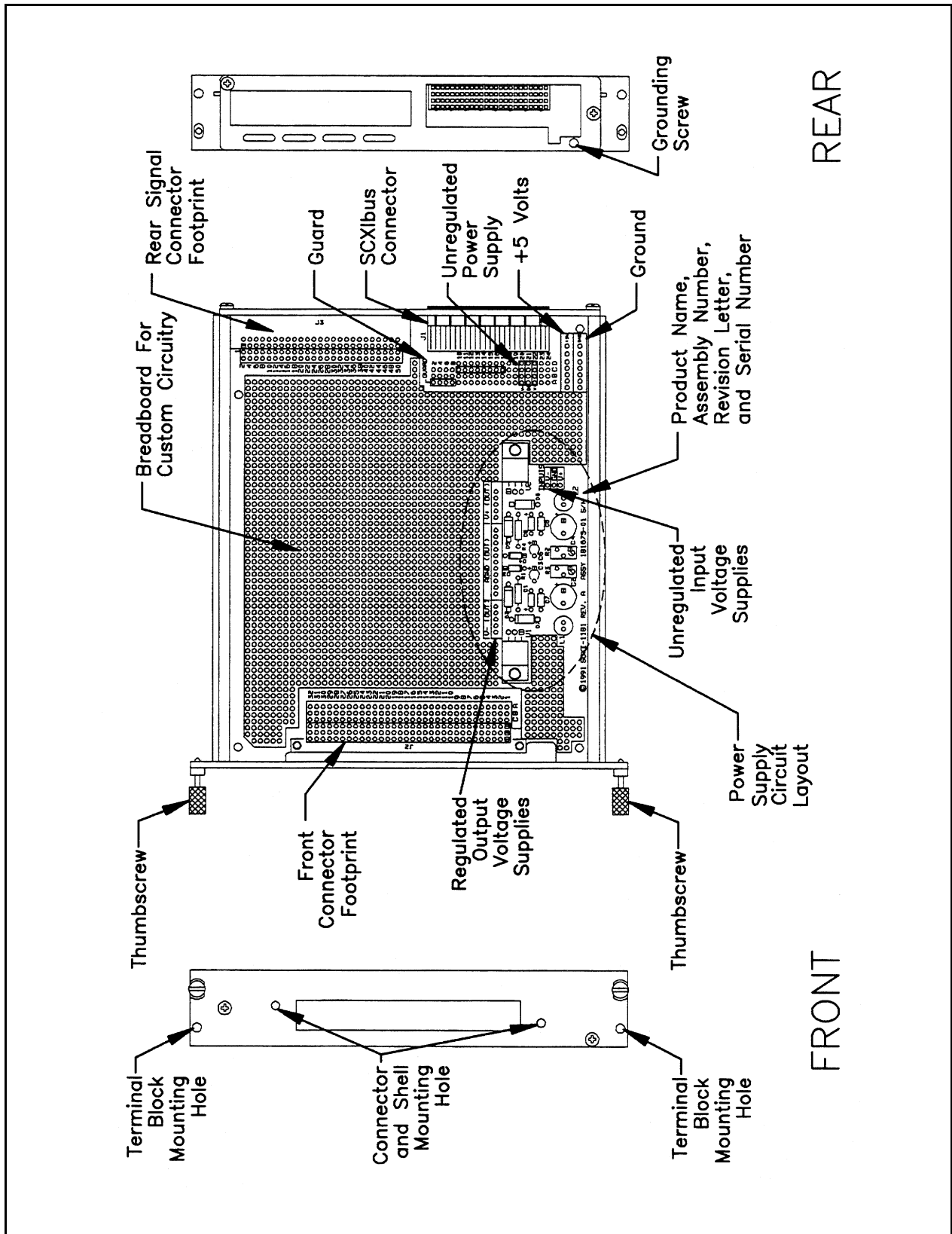

Figure 3-2. SCXI-1181 Module Parts Locator Diagram

Breadboarding Area

The breadboarding area consists of a perforated board space for building custom circuits.

Connectors

The SCXI-1181 module has three connectors. The front connector is a 96-pin DIN C-type connector. The rear signal connector is a 50-pin right-angle male ribbon-cable connector. Your SCXI-1181 kit includes both connectors. The third connector, the SCXIBus connector, is on the SCXI-1181 module. All three connectors have numbered pads on the breadboard for easy signal connection.

Figure 3-3 shows the pinout of the SCXIBus connector.

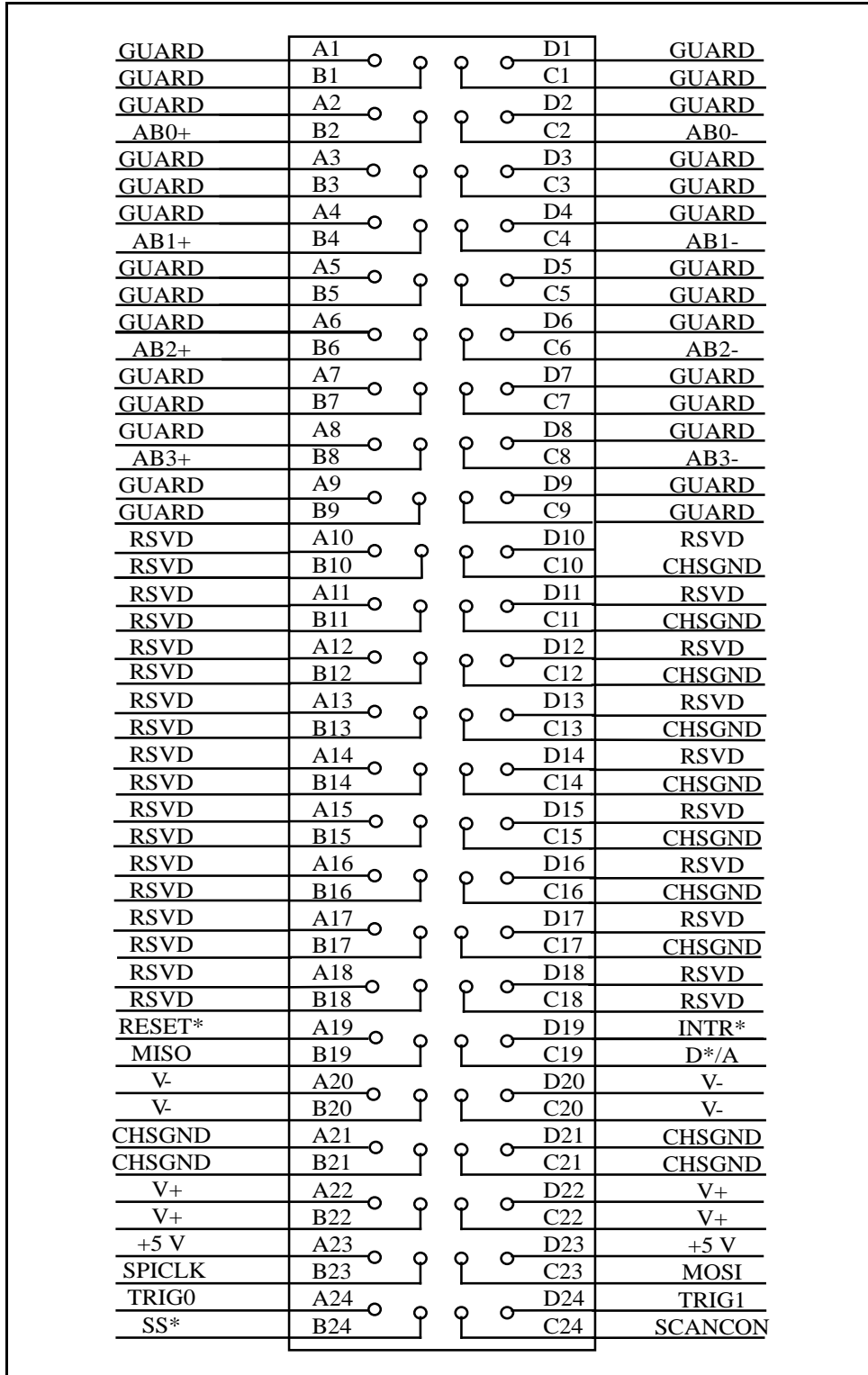

Figure 3-3. SCXI-1181 SCXibus Connector Pin Assignment

SCXIBus Connector Signal Descriptions

Pin	Signal	Description
A1, B1, C1, D1, A2, D2, A3, B3, C3, D3, A4, D4, A5, B5, C5, D5, A6, D6, A7, B7, C7, D7, A8, D8, A9, B9, C9, D9	GUARD from noise.	Guard – Shield and guard the analog bus lines
B2	AB0+	Analog Bus 0+ – Positive analog bus 0 line.
C2	AB0-	Analog Bus 0- – Negative analog bus 0 line.
B4	AB1+	Analog Bus 1+ – Positive analog bus 1 line.
C4	AB1-	Analog Bus 1- – Negative analog bus 1 line.
B6	AB2+	Analog Bus 2+ – Positive analog bus 2 line.
C6	AB2-	Analog Bus 2- – Negative analog bus 2 line.
B8	AB3+	Analog Bus 3+ – Positive analog bus 3 line.
C8	AB3-	Analog Bus 3- – Negative analog bus 3 line.
A10-A18, B10-B18, C18, D10-D18	RSVD	Reserved – For future use.
C10-C17, A21, B21, C21, D21	CHSGND	Chassis Ground – Digital and analog ground reference.
A19	RESET*	Reset – When pulled low, this pin reinitializes the module to its power-on state. Totem pole. Input.
B19	MISO	Master-In-Slave-Out – Transmits data from the module to the SCXIBus. Open collector. I/O.
C19	D*/A	Data/Address – Indicates to the module whether address information or data information is being sent to the module on MOSI. Open collector. I/O.
D19	INTR*	Interrupt – Open collector. I/O.
A20, B20, C20, D20	V-	Negative Analog Supply – Unregulated. Range: -18.5 V to -25 V at 170 mA.
A22, B22, C22, D22	V+	Positive Analog Supply – Unregulated. Range: +18.5 V to +25 V at 170 mA.

Pin	Signal	Description (continued)
A23, D23	+5 V	+5 VDC at 50 mA Source – Digital power supply.
B23	SPICLK	Serial Peripheral Interface (SPI) Clock – Clocks the serial data on the MOSI and MISO lines. Open collector. I/O.
C23	MOSI	Master-Out-Slave-In – Transmits data from the SCXIbus to the module. Open collector. I/O.
A24	TRIG0	TRIG0 – General-purpose trigger line. Open collector. I/O.
B24	SS*	Slot Select – When low, enables module communications over the SCXIbus. Totem pole. Input.
C24	SCANCON	Scanning Control – Combination output enable and reload signal for scanning operations. Totem pole. Input.
D24	TRIG1	TRIG1 – General-purpose trigger line. Open collector. I/O.

* Indicates active low.

Note: The SCXI-1000/1001 chassis does not supply pins A7 through D18.

MOSI, MISO, SPICLK, and SS* form a synchronous communication link that conforms to SPI standards using an idle-high clock and second-edge data latching. D*/A, INTR*, and RESET* are additional control signals.

Power Supply

The power supply section consists of a circuit layout for easy installation of positive and negative variable voltage regulators. Figure 3-2 shows the location of the circuit layout.

Figures 3-4 and 3-5 show the schematics of the positive and negative power supplies, respectively. Recommended values and parts are also indicated. It is important to mount the polarized capacitors in the correct direction as indicated on the schematic and in Figure 3-6, the detailed SCXI-1181 power supply circuit layout.

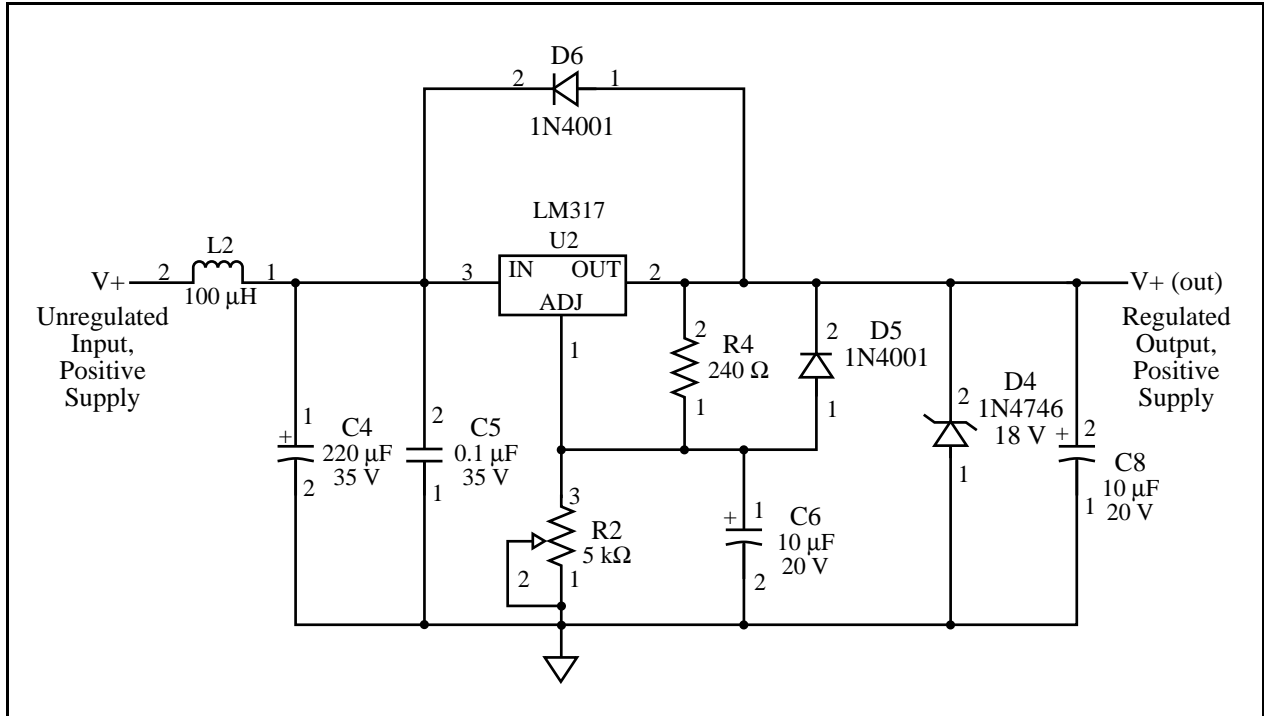

Figure 3-4. Schematic of the SCXI-1181 Positive Power Supply

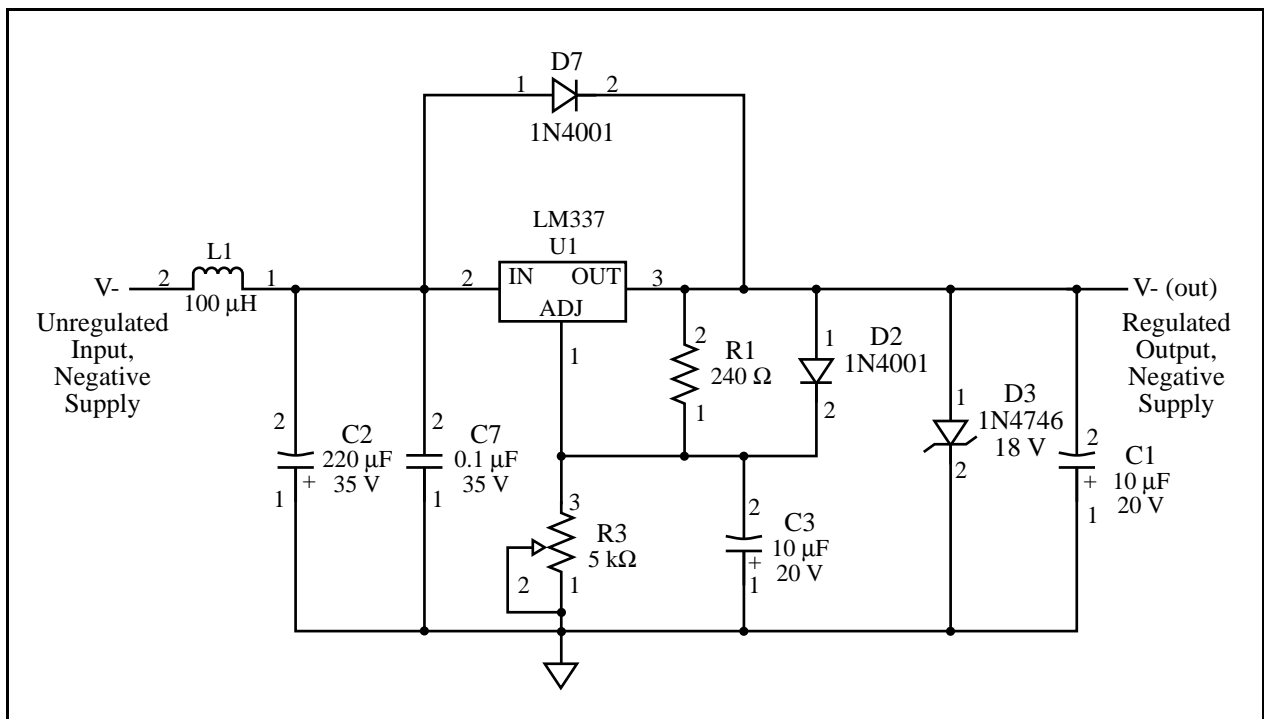

Figure 3-5. Schematic of the SCXI-1181 Negative Power Supply

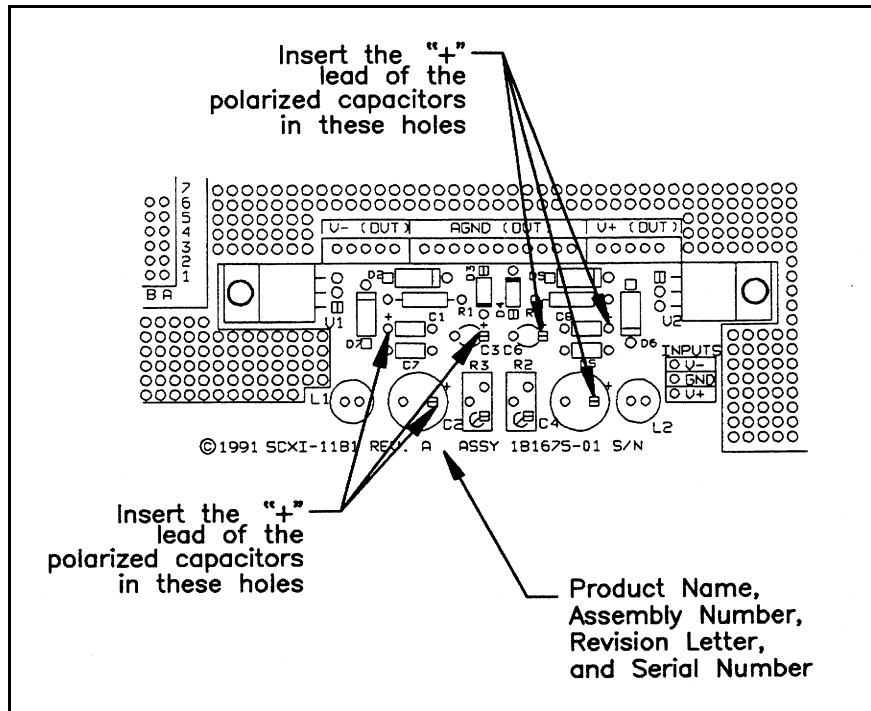

Figure 3-6. Detail of the SCXI-1181 Power Supply Circuit Layout

Using and Building Circuits on the SCXI-1181

To start building circuits on the SCXI-1181, remove the rear panel and slide the board out of its enclosure. If necessary, place both the front and rear signal connectors in their appropriate places as indicated on the module. Build your circuit. When you are done, slide the board back into its enclosure, making sure that the components and leads do not touch the enclosure (maximum component height is 0.7 in. and lead length is 0.1 in.). To remove the cover, first remove the grounding screw, if any, on the rear panel. Then twist a flathead screwdriver in the groove on the bottom side of the enclosure.

Warning: The SCXI-1181 is not intended for use with hazardous voltages (voltages exceeding 42 Vrms). You assume all risk associated with user-installed circuitry. National Instruments is *not* liable for any damages or injuries resulting from improper installation.

Building the Power Supply

The SCXI-1181 has a circuit layout for easy installation of positive and negative adjustable voltage regulators. Figure 3-2 shows the location of this circuit layout.

Table 3-1 lists recommended parts and their electrical specifications.

Table 3-1. SCXI-1181 Recommended Parts List

Reference Designator	Part Description
C1, C3, C6, C8	10 μ F, 20 V tantalum capacitor, 199D package
C2, C4	220 μ F, 35 V aluminum polarized capacitor, radial leads
C5, C7	0.1 μ F, 35 V ceramic capacitor, spincap, axial lead
D2, D5 through D7	1N4001 diode
D3, D4	1N4746, 18 V, 1 W zener
L1, L2	100 μ H inductor, radial, 300 mA
R1, R4	240 Ω , 1/4 W resistor, RC-07 package
R2, R3	5 k Ω potentiometer, top-adjustable, 3296Y package
U1	LM337 negative three-terminal adjustable regulator, TO-220 package
U2	LM317 positive three-terminal adjustable regulator, TO-220 package

Specifications

The following specifications apply to the SCXI-1181 power supply using the recommended parts:

Regulated Output Voltage

V+	+15 V maximum +1.25 V minimum
V-	-15 V maximum -1.25 V minimum

Line Regulation 0.02%/V typical

Load Regulation 0.3% typical

Current Output

I+	170 mA maximum
I-	170 mA maximum

After you load the components, connect the unregulated supplies and chassis ground to the V+, V-, and GND input pads. You can add fuses and heat sinks if necessary.

Note: National Instruments recommends that you fuse the unregulated V+ and V- supplies with 250 mA fast-acting fuses on your module. In case of a fault, these fuses will protect your module better than the higher value fuses in the SCXI chassis. You can access and replace the fuses on your breadboard module more easily than the fuses on the backplane behind the SCXI chassis fan.

Use potentiometers R2 and R3 to adjust the positive and negative output voltage supplies, respectively. Make this adjustment by rotating the wiper screw of each potentiometer. Use V-, V+, and AGND output pads for easy access to the regulated supplies.

Soldering and Desoldering on the SCXI-1181 Module

Use a low-wattage soldering iron (20 W to 30 W) when soldering to the module. When you desolder on the SCXI-1181, vacuum-type tools work best. Use care when desoldering to avoid damaging component pads. You should use only resin-core electronic-grade solder. Acid-core solder damages the printed circuit board and its components.

SCXI-1181 Installation

Perform the following steps to install the SCXI-1181 in any available SCXI backplane:

1. Turn off the computer that contains your data acquisition plug-in board or disconnect the board from your SCXI chassis.
2. Turn off the SCXI chassis.
3. Insert the SCXI-1181 into the guide rails of an empty slot. If a cable assembly has already been installed in the rear of the chassis, make sure that the module and cable assembly are firmly engaged; however, do not *force* the module into place.
4. Screw the front panel of the SCXI-1181 to the top and bottom threaded strips of your SCXI chassis.
5. If you use this module with an SCXI-1340 or SCXI-1351 cable assembly, attach the connector at the metal end of the cable assembly to the rear signal connector on the SCXI-1181 module. Screw the rear panel to the rear threaded strip. Secure the loose end of the cable as needed. For more information, see Appendix A, *Cabling*.
6. Check the installation.
7. Turn on the SCXI chassis.
8. Turn on the computer or reconnect the board to your chassis.

The SCXI-1181 module is installed and ready for operation.

SCXI-1181 Signal Connections

If you are using the 96-pin front connector included in your SCXI-1181 kit, you can use two types of signal breakouts to connect signals to the SCXI-1181 inputs—the SCXI-1300 and SCXI-1301 terminal blocks, and the SCXI-1310 and SCXI-1330 connector-and-shell assembly.

SCXI-1300 Terminal Block

The SCXI-1300 terminal block consists of a shielded board with supports to connect the terminal block to the SCXI-1181 front connector. The terminal block has 70 screw terminals for easy signal connection.

SCXI-1300 Onboard Temperature Sensor

You can use a temperature sensor that is mounted on the SCXI-1300 for thermocouple cold-junction compensation. You can connect the temperature sensor to the MTEMP pin (A3) or the DTEMP pin (A4).

The temperature sensor outputs 10 mV/°C and has an accuracy of $\pm 1^\circ\text{C}$ over the 0° to 55°C temperature range. To determine the ambient temperature measured by the temperature sensor, use the following formulas:

$$T(^{\circ}\text{C}) = 100 \times V_{\text{TEMPOUT}}$$

$$T(^{\circ}\text{F}) = T(^{\circ}\text{C}) \times 9/5 + 32$$

where V_{TEMPOUT} is the temperature sensor output and $T(^{\circ}\text{F})$ and $T(^{\circ}\text{C})$ are the temperature readings in degrees Fahrenheit and degrees Celsius, respectively.

Configuration

Jumper Configuration

Figure 3-9 shows a parts locator diagram for the SCXI-1300 terminal block. In addition to the screw terminals, you can use two jumpers to configure the onboard temperature sensor:

- Jumper W1 (MTEMP). This is the factory setting.
- Jumper W2 (DTEMP)

In both modes, the chassis ground pin on the SCXI-1300 is the reference to the temperature sensor signal.

One jumper block comprises both jumpers; hence, you can use only one type of configuration at a time. The parking position for the jumper block is the MTEMP position.

Figure 3-7 maps the SCXI-1300 screw terminals to the connector pins.

Pin Number	Signal Name	Column			Signal Name	
		A	B	C		
32	CGND	○	○	○	CH0-	
31		○	○	○	CH0+	
30		○	○	○	CH1-	
29		○	○	○	CH1+	
28		○	○	○	CH2-	
27		○	○	○	CH2+	
26		○	○	○	CH3-	
25		○	○	○	CH3+	
24		CGND	○	○	○	CH4-
23			○	○	○	CH4+
22	○		○	○	CH5-	
21	○		○	○	CH5+	
20	○		○	○	CH6-	
19	○		○	○	CH6+	
18	○		○	○	CH7-	
17	○		○	○	CH7+	
16	CGND		○	○	○	CH8-
15			○	○	○	CH8+
14		○	○	○	CH9-	
13		○	○	○	CH9+	
12		○	○	○	CH10-	
11		○	○	○	CH10+	
10		○	○	○	CH11-	
9		○	○	○	CH11+	
8		OUTPUT	○	○	○	CH12-
7			○	○	○	CH12+
6	○		○	○	CH13-	
5	○		○	○	CH13+	
4	○		○	○	CH14-	
3	○		○	○	CH14+	
2	○		○	○	CH15-	
1	○		○	○	CH15+	
	AOREF		○	○	○	CH16-
	GUARD		○	○	○	CH16+
	CGND	○	○	○	CH17-	
	DTEMP	○	○	○	CH17+	
	MTEMP	○	○	○	CH18-	
	CGND	○	○	○	CH18+	
	+5 V	○	○	○	CH19-	
		○	○	○	CH19+	
		○	○	○	CH20-	
		○	○	○	CH20+	
		○	○	○	CH21-	
		○	○	○	CH21+	
		○	○	○	CH22-	
		○	○	○	CH22+	
		○	○	○	CH23-	
		○	○	○	CH23+	
		○	○	○	CH24-	
		○	○	○	CH24+	
		○	○	○	CH25-	
		○	○	○	CH25+	
		○	○	○	CH26-	
		○	○	○	CH26+	
		○	○	○	CH27-	
		○	○	○	CH27+	
		○	○	○	CH28-	
		○	○	○	CH28+	
		○	○	○	CH29-	
		○	○	○	CH29+	
		○	○	○	CH30-	
		○	○	○	CH30+	
		○	○	○	CH31-	
		○	○	○	CH31+	

Figure 3-7. SCXI-1300 Screw Terminal/Connector Pin Assignment

SCXI-1301 Terminal Block

The SCXI-1301 terminal block is similar to the SCXI-1300 but has only 20 terminals and no temperature sensor.

Figure 3-8 maps the SCXI-1301 screw terminals to the connector pins.

Pin Number	Signal Name	Column			Signal Name
		A	B	C	
32	CH0+	○	○	○	CH0-
31		○	○	○	
30	CH1+	○	○	○	CH1-
29		○	○	○	
28		○	○	○	
27		○	○	○	
26	CH2+	○	○	○	CH2-
25		○	○	○	
24	CH3+	○	○	○	CH3-
23		○	○	○	
22		○	○	○	AGND
21		○	○	○	
20	CH4+	○	○	○	CH4-
19		○	○	○	
18	CH5+	○	○	○	CH5-
17		○	○	○	
16		○	○	○	
15		○	○	○	
14	CH6+	○	○	○	CH6-
13		○	○	○	
12	CH7+	○	○	○	CH7-
11		○	○	○	
10		○	○	○	
9		○	○	○	
8		○	○	○	
7		○	○	○	
6	HOLD	○	○	○	GND
5		○	○	○	
4		○	○	○	
3		○	○	○	
2		○	○	○	
1		○	○	○	

Figure 3-8. SCXI-1301 Screw Terminal/Connector Pin Assignment

SCXI-1300 and SCXI-1301 Signal Connection

Perform the following steps to connect signals to an SCXI-1300 or SCXI-1301 terminal block:

1. Remove the grounding screw of the top cover, as shown in Figure 2-7.
2. Pry open the top cover of the shield by twisting a flathead screwdriver in the groove at the bottom of the terminal block.
3. Slide the signal wires through the front panel strain-relief opening. You can add padding inside the strain-relief opening if necessary.
4. Connect the wires to the screw terminals.
5. Tighten the larger strain-relief screws on the strain-relief bar.
6. Snap the top cover back in place.
7. Reinsert the grounding screw to ensure proper shielding.
8. Connect the terminal block to the SCXI-1181 front connector and tighten the top and bottom mounting screws.

Figures 3-9 and 3-10 show the SCXI-1300 and SCXI-1301 parts locator diagrams.

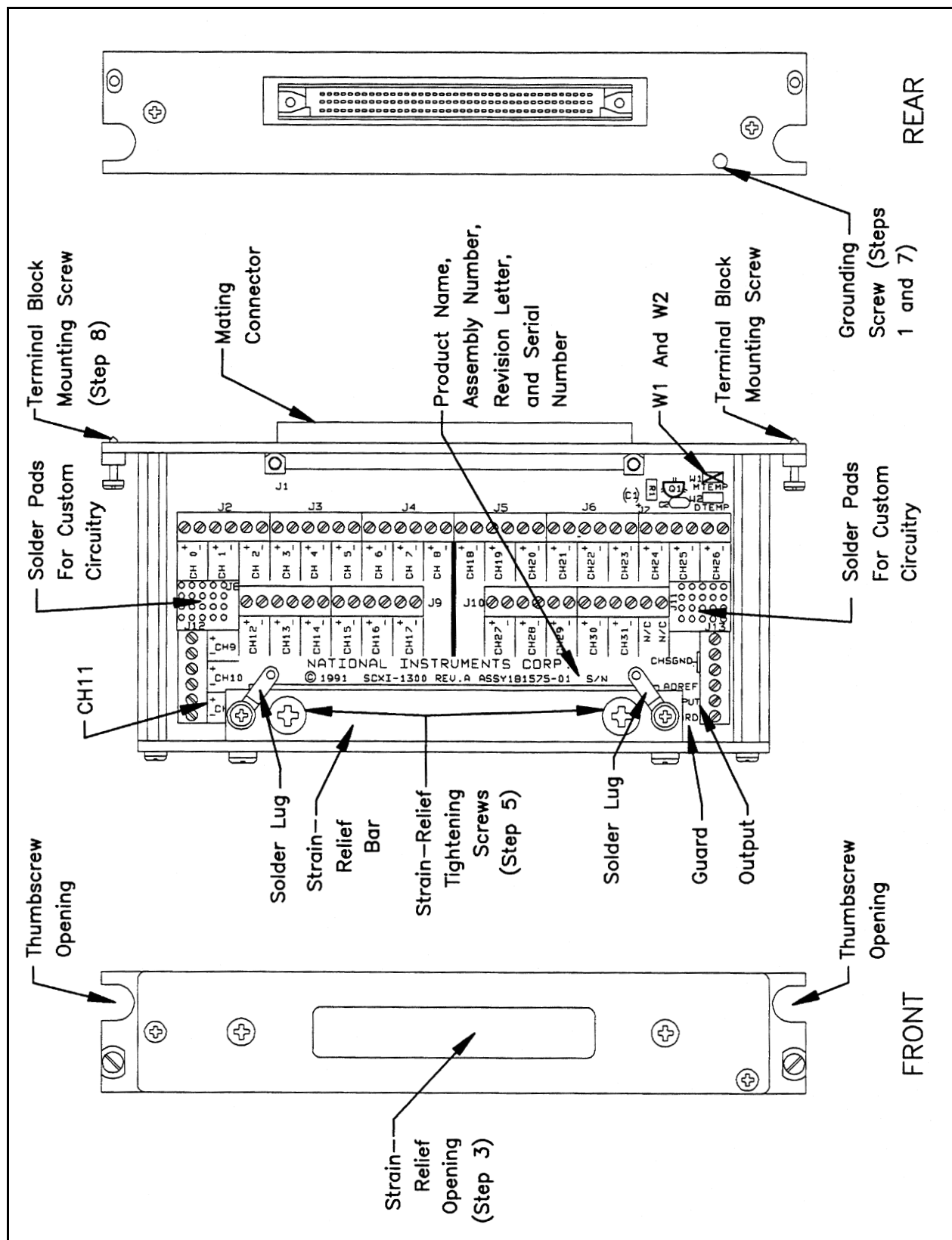

Figure 3-9. SCXI-1300 Parts Locator Diagram

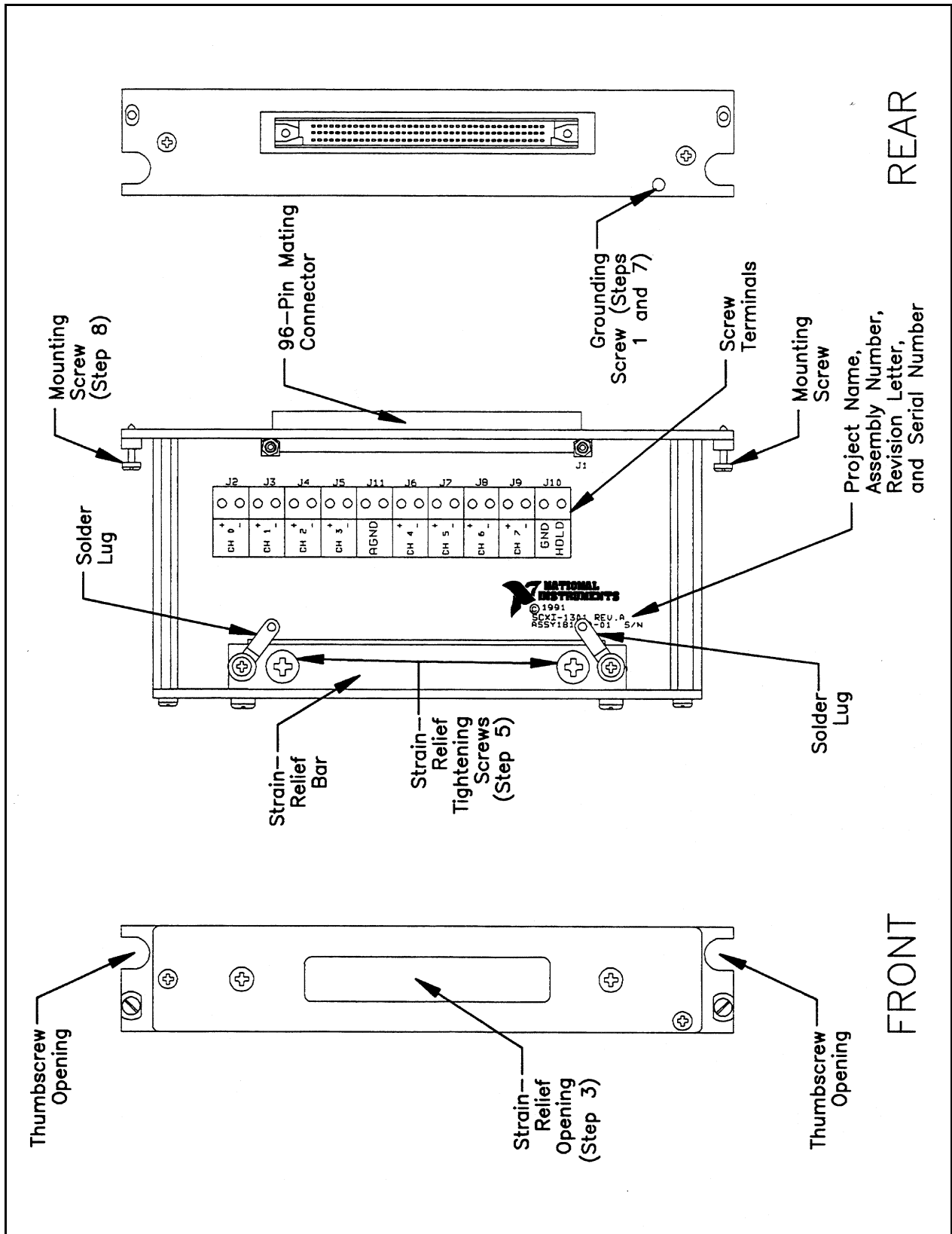

Figure 3-10. SCXI-1301 Parts Locator Diagram

SCXI-1310 Connector-and-Shell Assembly

With the SCXI-1310 kit, you can build your own signal cable to connect to the SCXI-1181 inputs. The connector has eyelet-type ends for easy hook-and-solder signal connection. Use the shell to cover and protect the connector after you build the cable.

SCXI-1330 Connector-and-Shell Assembly

The SCXI-1330 kit is similar to the SCXI-1310, but has only 32 terminals (rows A and C, even-numbered pins only).

Note: The SCXI-1330 connector is keyed for use with high-voltage modules. To use the SCXI-1330 with the SCXI-1181, remove these keys by sliding the keys out of their dovetail grooves.

Warning: The SCXI-1181 is not intended for use with hazardous voltages (voltages exceeding 42 Vrms). National Instruments is *not* liable for any damages or injuries resulting from improper installation.

SCXI-1310 and SCXI-1330 Installation

To mount the connector to the front of the module, install two jack screws as shown in Figure 3-11 to firmly hold the connector-and-shell assembly to the SCXI chassis. Perform the following steps to assemble and mount the connector-and-shell assembly to your SCXI module:

1. Refer to the diagram included with your SCXI-1310 or SCXI-1330 kit and Figure 3-11, *Building and Mounting the SCXI-1310 or SCXI-1330 Connector-and-Shell Assembly*, to build the connector-and-shell assembly.
2. Turn off the computer that contains your plug-in board or disconnect the board from your SCXI chassis.
3. Turn off your SCXI chassis.
4. Slide the module out of the chassis.
5. Remove the module cover. Refer to Figure 3-11 as you complete the remaining steps.
6. Place one jack screw as indicated in Figure 3-11.
7. While holding the screw in place, insert the lock washer, then the nut. Notice that you may need long-nose pliers to insert the washer and nut.
8. Tighten the nut by holding it firmly while rotating the jack screw.
9. Repeat steps 6 through 8 for the second jack screw.
10. Replace the module cover and tighten the grounding screw.
11. Slide the module back in place.
12. Connect the connector-and-shell assembly to your module front connector and secure the assembly by tightening both mounting screws.

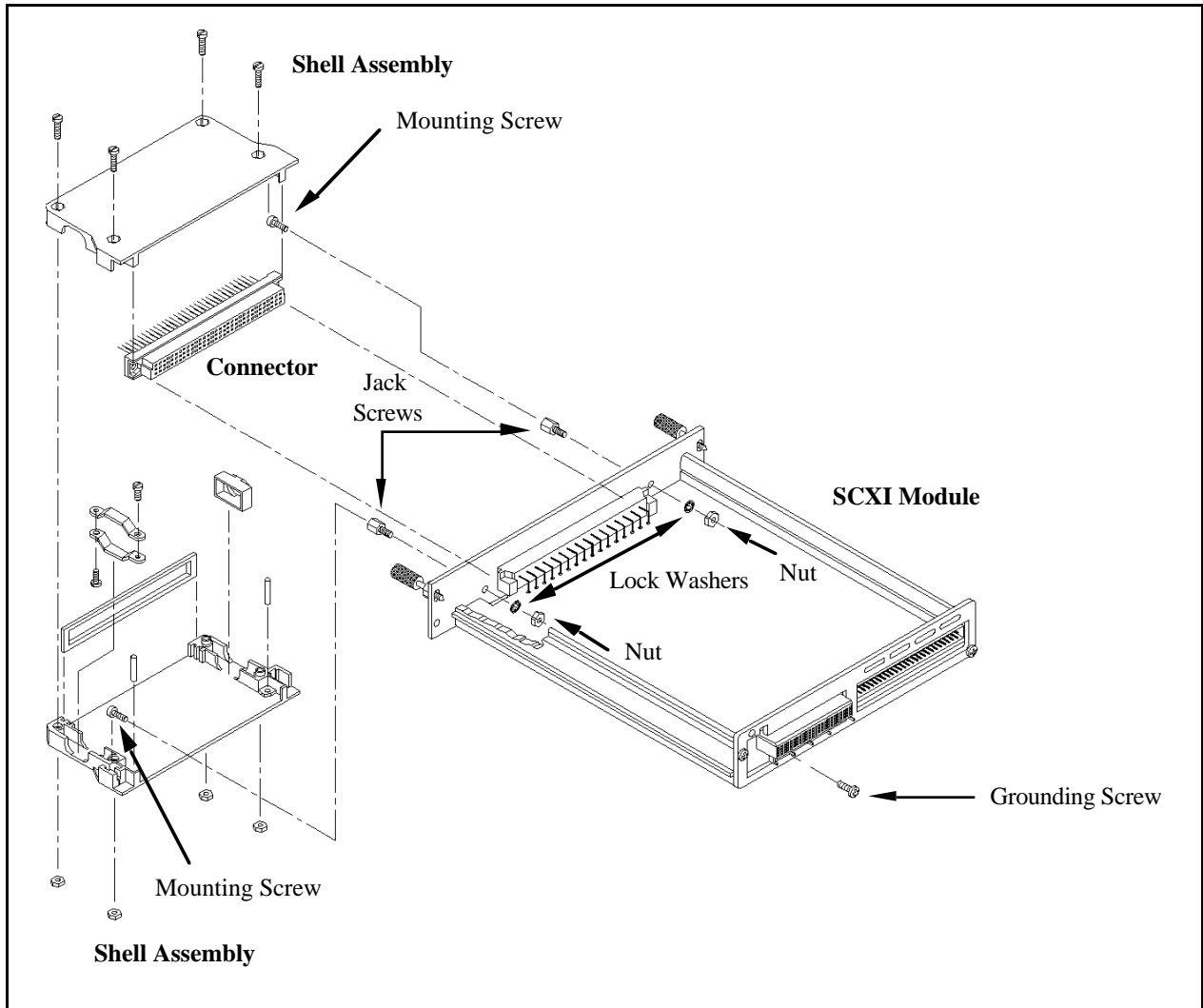

Figure 3-11. Building and Mounting the SCXI-1310 or SCXI-1330 Connector-and-Shell Assembly

Appendix A

Cabling

This appendix explains the installation and operation of the cabling accessories you can use with the SCXI-1180 and SCXI-1181. These accessories include the following:

- SCXI-1340 cable assembly
- SCXI-1351 one-slot cable extender
- SCXI-1343 screw terminal adapter

Note: You can use these cable assemblies with the SCXI-1181 if you use the rear signal connector included with your SCXI-1181 kit.

SCXI-1340 Cable Assembly

The SCXI-1340 cable assembly consists of a 50-conductor ribbon cable that has a mounting bracket at one end and a 50-pin female connector at the other end. The female connector connects to the I/O connector of a plug-in board or instrument. Attached to the mounting bracket is a 50-pin female mounting-bracket connector that connects to the module rear signal connector. To extend the signals of the plug-in board to another module, you can use the male breakout connector that is near the mounting bracket on the ribbon cable. All 50 pins from the plug-in board go straight through to the rear signal connector. You can use a standard 50-pin ribbon cable instead of the SCXI-1340 cable assembly. The SCXI-1340 has the following advantages over the ribbon cable:

- The SCXI-1340 provides strain relief so that you cannot accidentally disconnect the cable.
- The SCXI-1340 includes a mounting bracket that mounts to the chassis so that you can remove and reinsert the SCXI-1181 without explicitly removing the cable from the back of the chassis. This is especially useful when the SCXI chassis is rack mounted, making rear access difficult.
- The SCXI-1340 has an extra male breakout connector for use with the SCXI-1180 feedthrough panel or additional modules that require a direct connection to the plug-in board.
- The SCXI-1340 rear panel gives both mechanical and electrical shielding.

SCXI-1340 Installation

Perform the following steps to install the SCXI-1340:

1. Make sure that the computer and the SCXI chassis are turned off.
2. Install the SCXI module in the chassis.
3. Plug the mounting bracket connector onto the module rear signal connector as shown in Figure A-1. Make sure the alignment tab on the bracket enters the upper board guide of the chassis.
4. Screw the mounting bracket to the threaded strips in the rear of the chassis.
5. Connect the loose end of the cable assembly to the plug-in board I/O connector.

Check the installation.

The order of these steps is not critical; however, it is easier to locate the correct position for the mounting bracket with a module installed in the chassis. If you attach a cable to the breakout connector, attach the second cable before installing the SCXI-1340.

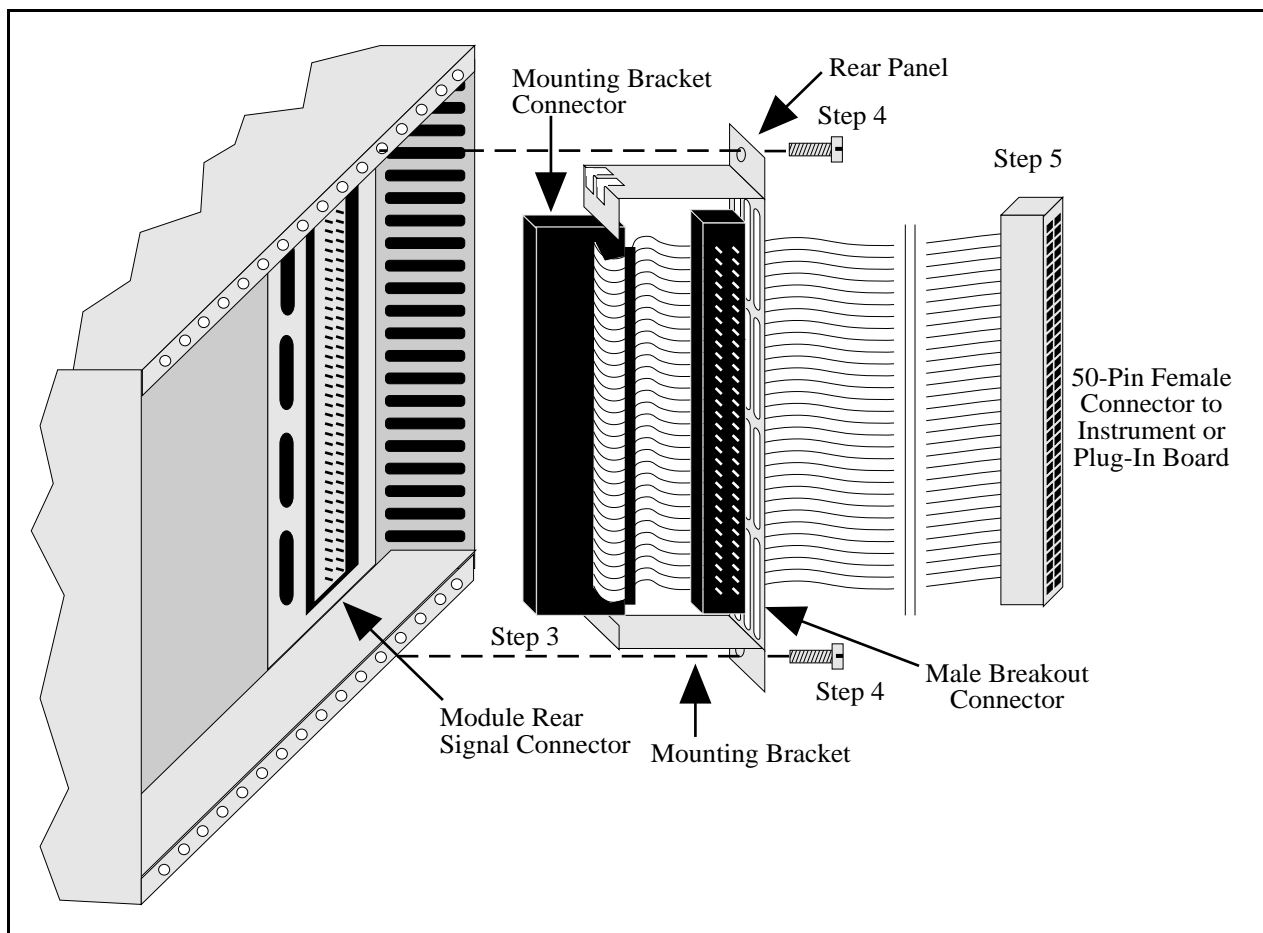

Figure A-1. SCXI-1340 Installation

SCXI-1351 One-Slot Cable Extender

The SCXI-1351 cable extender is a miniature SCXI-1340 cable assembly. Instead of connecting to a plug-in board 1 m away, the SCXI-1351 female rear connector connects to a male breakout connector of a board that must be in the rear connector space of the slot to the left. The SCXI-1351 has a female mounting bracket connector that mates with the rear signal connector of a module, and also has a male breakout connector on the ribbon cable to connect to a feedthrough panel or more cable extenders.

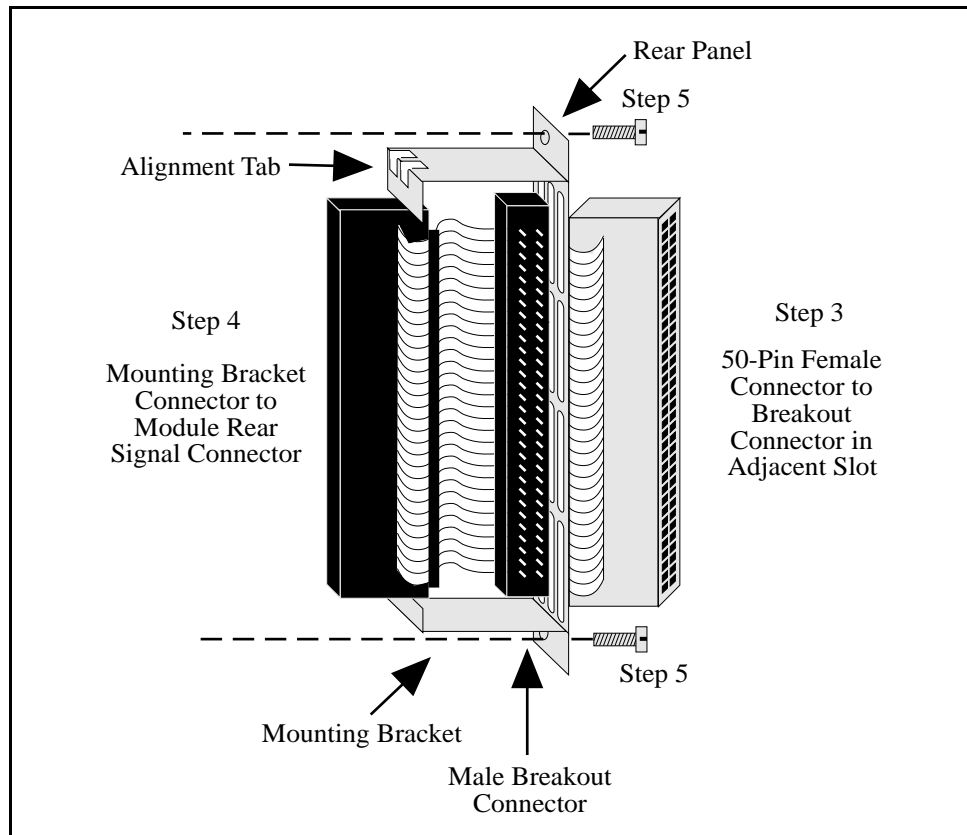

Figure A-2. SCXI-1351 Installation

SCXI-1351 Installation

Perform the following steps to install the SCXI-1351 (refer to Figure A-2):

1. Make sure that the computer and the SCXI chassis are turned off.
2. Install the SCXI module in the chassis.
3. Connect the rear connector of the cable extender to the breakout connector in the adjacent slot to the left.
4. Plug the mounting bracket connector to the module rear signal connector. Make sure the alignment tab on the bracket enters the upper board guide of the chassis.

5. Screw the mounting bracket to the threaded strips in the rear of the chassis.
6. Use the breakout connector to connect to an SCXI-1180 or another SCXI-1351/SCXI-1181 pair.

Check the installation.

SCXI-1343 Rear Screw Terminal Adapter

Use the SCXI-1343 universal adapter to adapt custom wiring to the SCXI-1181. Use the screw terminals for the analog output connections and the solder pads for the rest of the signals. A strain-relief device is outside of the rear panel. Table A-1 shows the SCXI-1343 pin connections.

SCXI-1343 Installation

1. Insert each wire through the adapter strain relief.
2. Make all solder connections first.
3. Connect the other wires to the screw terminals.
4. Tighten the strain-relief screws to secure the wires.
5. Plug the adapter board front connector to the module rear signal connector. Make sure a corner of the adapter board enters the upper board guide of the chassis.
6. Screw the rear panel to the threaded strips in the rear of the chassis.

Table A-1. SCXI-1343 Pin Connections

Rear Signal Connector Pin	Connection Type
1	Solder pad
2	Screw terminal
3	Screw terminal
4	Screw terminal
5	Screw terminal
6	Screw terminal
7	Screw terminal
8	Screw terminal
9	Screw terminal
10	Screw terminal
11	Screw terminal
12	Screw terminal
13	Screw terminal

(continues)

Table A-1. SCXI-1343 Pin Connections (Continued)

Rear Signal Connector Pin	Connection Type
14	Screw terminal
15	Screw terminal
16	Screw terminal
17	Screw terminal
18	Screw terminal
19	Screw terminal
20	Solder pad
21	Solder pad
22	Solder pad
23	Solder pad
24	Solder pad
25	Solder pad
26	Solder pad
27	Solder pad
28	Solder pad
29	Solder pad
30	Solder pad
31	Solder pad
32	Solder pad
33	Solder pad
34	Solder pad
35	Solder pad
36	Solder pad
37	Solder pad
38	Solder pad
39	Solder pad
40	Solder pad
41	Solder pad
42	Solder pad
43	Solder pad
44	Solder pad
45	Solder pad
46	Solder pad
47	Solder pad
48	Solder pad
49	Solder pad
50	Solder pad

Appendix B

Customer Communication

For your convenience, this appendix contains forms to help you gather the information necessary to help us solve technical problems you might have as well as a form you can use to comment on the product documentation. Filling out a copy of the *Technical Support Form* before contacting National Instruments helps us help you better and faster.

National Instruments provides comprehensive technical assistance around the world. In the U.S. and Canada, applications engineers are available Monday through Friday from 8:00 a.m. to 6:00 p.m. (central time). In other countries, contact the nearest branch office. You may fax questions to us at any time.

Corporate Headquarters

(512) 795-8248

Technical support fax: (800) 328-2203

(512) 794-5678

Branch Offices	Phone Number	Fax Number
Australia	(03) 879 9422	(03) 879 9179
Austria	(0662) 435986	(0662) 437010-19
Belgium	02/757.00.20	02/757.03.11
Denmark	45 76 26 00	45 76 71 11
Finland	(90) 527 2321	(90) 502 2930
France	(1) 48 14 24 00	(1) 48 14 24 14
Germany	089/741 31 30	089/714 60 35
Italy	02/48301892	02/48301915
Japan	(03) 3788-1921	(03) 3788-1923
Mexico	95 800 010 0793	95 800 010 0793
Netherlands	03480-33466	03480-30673
Norway	32-848400	32-848600
Singapore	2265886	2265887
Spain	(91) 640 0085	(91) 640 0533
Sweden	08-730 49 70	08-730 43 70
Switzerland	056/20 51 51	056/20 51 55
Taiwan	02 377 1200	02 737 4644
U.K.	0635 523545	0635 523154

Technical Support Form

Photocopy this form and update it each time you make changes to your software or hardware, and use the completed copy of this form as a reference for your current configuration. Completing this form accurately before contacting National Instruments for technical support helps our applications engineers answer your questions more efficiently.

If you are using any National Instruments hardware or software products related to this problem, include the configuration forms from their user manuals. Include additional pages if necessary.

Name _____

Company _____

Address _____

Fax (____) _____ Phone (____) _____

Computer brand _____ Model _____ Processor _____

Operating system _____

Speed _____ MHz RAM _____ M Display adapter _____

Mouse _____yes _____no Other adapters installed _____

Hard disk capacity _____ M Brand _____

Instruments used _____

National Instruments hardware product model _____ Revision _____

Configuration _____

National Instruments software product _____ Version _____

Configuration _____

The problem is _____

List any error messages _____

The following steps will reproduce the problem _____

SCXI-1180/1181 Hardware Configuration Form

Record the settings and revisions of your hardware on the line located to the right of each item. In addition, fill out the hardware and software configuration forms for the SCXI chassis and plug-in board. Completing these forms accurately before contacting National Instruments for technical support helps our applications engineers answer your questions more efficiently.

- SCXI-1180 Revision _____
- Chassis Type and Revision _____
- Chassis Slot _____
- Rear Signal Connector Connected to _____
- Breakout Connector Connected to _____
- System Description _____

- SCXI-1181 Revision _____
- Chassis Type and Revision _____
- Chassis Slot _____
- Rear Signal Connector Pin Connections _____
- System Description _____

- Are you using the power supply layout? _____ Yes _____ No
(If yes, include a list of the parts used.)
- You may need to include schematic drawings of your custom circuit.
- Any schematics included? _____ Yes _____ No
- If yes, how many pages? _____
- Other Modules in System _____

- Data Acquisition Boards Installed _____

Documentation Comment Form

National Instruments encourages you to comment on the documentation supplied with our products. This information helps us provide quality products to meet your needs.

Title: **SCXI-1180/1181 User Manual**

Edition Date: **March 1995**

Part Number: **371062A-01**

Please comment on the completeness, clarity, and organization of the manual.

If you find errors in the manual, please record the page numbers and describe the errors.

Thank you for your help.

Name _____

Title _____

Company _____

Address _____

Phone (_____) _____

Mail to: Technical Publications
National Instruments Corporation
6504 Bridge Point Parkway, MS 53-02
Austin, TX 78730-5039

Fax to: Technical Publications
National Instruments Corporation
MS 53-02
(512) 794-5678

Glossary

Prefix	Meaning	Value
μ-	micro-	10 ⁻⁶
m-	milli-	10 ⁻³
k-	kilo-	10 ³

°	degrees
Ω	ohms
%	percent
+5 V (signal)	+5 VDC at 50 mA Source pin
A	amperes
AB#+	Positive Analog Bus number line
AB#-	Negative Analog Bus number line
A/D	analog-to-digital
AGND	analog ground
C	Celsius
CHSGND	Chassis Ground
D/A	digital-to-analog
D*/A	Data/Address
DC	direct current
DIN	Deutsche Industrie Norme
DIO	digital I/O
DTEMP	direct temperature sensor
F	Fahrenheit
F	farads
GND	ground
GUARD	Guard
H	henrys
I+	positive analog supply current
I-	negative analog supply current
I/O	input/output
in.	inches
INTR*	Interrupt
M	megabytes of memory
MC	Micro Channel
MIO	multifunction I/O
MISO	Master-In-Slave-Out
MOSI	Master-Out-Slave-In
MTEMP	multiplexed temperature sensor
NB	NuBus
RAM	random-access memory
RESET*	Reset
RMA	Return Material Authorization
RSVD	Reserved
RTSI	Real-Time System Integration
SCANCON	Scanning Control

Glossary

SCXI	Signal Conditioning eXtensions for Instrumentation (bus)
SDK	Software Developer's Kit
SPI	Serial Peripheral Interface
SPICLK	Serial Peripheral Interface Clock
SS*	Slot Select
TRIG#	general-purpose trigger line
V	volts
V+	Positive Analog Supply
V-	Negative Analog Supply
VDC	volts direct current
VI	virtual instrument
V _{rms}	volts, root mean square
V _{TEMPOUT}	temperature sensor output
W	watts

Index

Numbers/Symbols

+5 V signal, 3-6

A

AB0+ signal, 3-5
AB0- signal, 3-5
AB1+ signal, 3-5
AB1- signal, 3-5
AB2+ signal, 3-5
AB2- signal, 3-5
AB3+ signal, 3-5
AB3- signal, 3-5

B

breadboard module. *See* SCXI-1181
breadboard module.

C

cabling
 SCXI-1340 cable assembly, A-1 to A-2
 SCXI-1343 rear screw terminal adapter,
 A-4 to A-5
 SCXI-1351 one-slot cable extender,
 A-3 to A-4
CHSGND signal, 3-5
circuits, using and building, 3-8 to 3-10
 power supply, 3-8 to 3-9
 recommended parts list, 3-9
 soldering and desoldering, 3-10
 specifications, 3-9
configuration, SCXI-1300 terminal
 block, 3-11
connectors
 SCXI-1181 breadboard module,
 3-3 to 3-6
 SCXI-1181 SCXibus connector
 (illustration), 3-4
 SCXI-1343 rear screw terminal adapter
 pin connections, A-4 to A-5

SCXibus signal descriptions, 3-5 to 3-6
customer communication, *viii*, B-1

D

D*/A signal, 3-5, 3-6
desoldering circuits, 3-10
documentation
 conventions used, *vii* to *viii*
 organization of manual, *vii*
 related documentation, *viii*

E

equipment, optional, 1-3

F

fax technical support, B-1
feedthrough panel. *See* SCXI-1180
 feedthrough panel.
fuses, 3-9

G

GUARD signal, 3-5

I

installation
 SCXI-1180 feedthrough panel, 2-6 to
 2-7
 SCXI-1181 breadboard module, 3-10
 SCXI-1302 terminal block, 2-7 to 2-9
 SCXI-1310 connector-and-shell
 assembly, 3-17 to 3-18
 SCXI-1330 connector-and-shell
 assembly, 3-17 to 3-18
 SCXI-1340, A-2

SCXI-1343 rear screw terminal
adapter, A-4
SCXI-1351 one-slot cable extender,
A-3 to A-4
INTR* signal, 3-5, 3-6

J

jumper configuration, SCXI-1300 terminal
block, 3-11

M

MISO signal, 3-5, 3-6
MOSI signal, 3-6

O

onboard temperature sensor, SCXI-1300
terminal block, 3-11

P

power supply, SCXI-1181 breadboard
module
building, 3-8 to 3-9
circuit layout, 3-8
negative power supply (schematic), 3-7
positive power supply (schematic), 3-7

R

RESET* signal, 3-5, 3-6
RSVD signal, 3-5

S

SCANCON signal, 3-6
SCXI-1180 feedthrough panel
as cable extender (illustration), 2-4
contents of kit, 1-1

as daisy-chain cable extender
(illustration), 2-5
description, 2-1 to 2-2
equipment, optional, 1-3
as extender (illustration), 2-3
illustration, 2-1
installation, 2-6 to 2-7
SCXI-1302 terminal block, 2-7 to 2-9
software, optional, 1-1 to 1-2
unpacking, 1-3
SCXI-1181 breadboard module
breadboarding area, 3-3
connectors, 3-3 to 3-6
contents of kit, 1-1
description, 3-1 to 3-8
equipment, optional, 1-3
illustration, 3-1
installation, 3-10
parts locator diagram, 3-2
power supply, 3-6 to 3-9
SCXIBus connector signal descriptions,
3-5 to 3-6
signal connections
installation of SCXI-1310 and
SCXI-1330, 3-17 to 3-18
overview, 3-10
SCXI-1300 and SCXI-1301 signal
connection, 3-14
SCXI-1300 terminal block, 3-10 to
3-12, 3-14 to 3-15
SCXI-1301 terminal block, 3-13 to
3-14, 3-16
SCXI-1310 connector-and-shell
assembly, 3-17 to 3-18
SCXI-1330 connector-and-shell
assembly, 3-17 to 3-18
software, optional, 1-1 to 1-2
unpacking, 1-3
using and building circuits, 3-8 to 3-10
power supply, 3-8
recommended parts list, 3-9
soldering and desoldering, 3-10
specifications, 3-9
SCXI-1300 terminal block
definition, 3-10
jumper configuration, 3-11
onboard temperature sensor, 3-11
parts locator diagram, 3-15
screw terminal/connector pin
assignment, 3-12
signal connection, 3-14
SCXI-1301 terminal block
overview, 3-13
parts locator diagram, 3-16

- screw terminal/connector pin
 - assignment, 3-13
 - signal connection, 3-14
- SCXI-1302 terminal block
 - installation, 2-7 to 2-9
 - parts locator diagram, 2-8
 - purpose and use, 2-7
- SCXI-1310 connector-and-shell assembly
 - installation, 3-17 to 3-18
 - purpose and use, 3-17
- SCXI-1330 connector-and-shell assembly
 - installation, 3-17 to 3-18
 - purpose and use, 3-17
- SCXI-1340
 - cable assembly, A-1
 - installation, A-2
- SCXI-1343 rear screw terminal adapter
 - cabling, A-4
 - installation, A-4
 - pin connections, A-4 to A-5
- SCXI-1351 one-slot cable extender
 - cabling, A-3
 - installation, A-3 to A-4
- SCXIbus connector signal descriptions, 3-5 to 3-6
- signal connections, SCXI-1181
 - overview, 3-10
 - SCXI-1300 terminal block
 - definition, 3-10
 - jumper configuration, 3-11
 - onboard temperature sensor, 3-11
 - parts locator diagram, 3-15
 - screw terminal/connector pin
 - assignment, 3-12
 - signal connection, 3-14
 - SCXI-1301 terminal block
 - definition, 3-13
 - parts locator diagram, 3-16
 - screw terminal/connector pin
 - assignment, 3-13
 - signal connection, 3-14
 - SCXI-1310 connector-and-shell
 - assembly
 - installation, 3-17 to 3-18
 - purpose and use, 3-17
 - SCXI-1330 connector-and-shell
 - assembly
 - installation, 3-17 to 3-18
 - purpose and use, 3-17
- signal descriptions. *See* connectors.
- soldering and desoldering circuits, 3-10
- specifications for building circuits, 3-9
- SPICLK signal, 3-6
- SS* signal, 3-6

T

- technical support, B-1
- TRIG0 signal, 3-6
- TRIG1 signal, 3-6

U

- unpacking SCXI products, 1-3

V

- V+ signal, 3-5
- V- signal, 3-5